

1  
RoHS Compliance

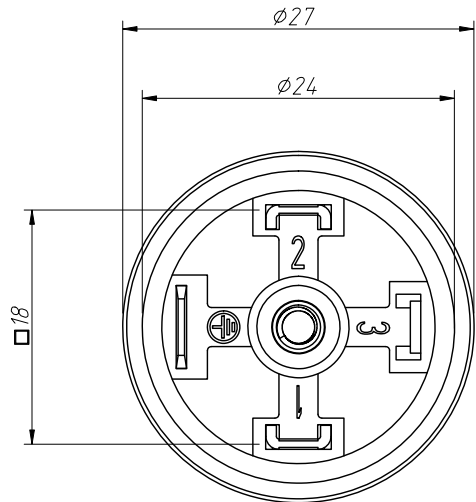
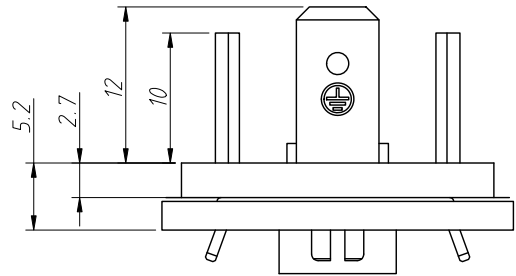

Notes:

Standard: DIN EN 175 301-803-A  
 Ambient Temperature:  $-30^{\circ}\text{C} \sim +125^{\circ}\text{C}$   
 Termination: Soldering  
 Pin Dimensions: 6.3x0.8mm, 4.8x0.8mm  
 Housing Color: Black  
 Housing Material: PA  
 Contact: Brass With  
     Tin Plated Or Nickel Plated  
 Central Nut: Brass With Nickel Plated  
 Gasket: NBR  
 Rated Voltage: 400V  
 Rated Impulse voltage: 4000V  
 Rated Current: 16A  
 Insulation Resistance:  $\geq 100\text{M}\Omega$   
 Contact Resistance:  $\leq 4\text{m}\Omega$   
 IP Rating: IP65 in locked condition

Order Information







L-KLS15-SVCB01-2+PE

RoHS

Plug Type

Contacts

3+PE, 2+2PE, 2+PE, 3P, 4P

Contacts	3+PE	2+2PE	2+PE	3P	4P
Certification	 ECBT2.E364453				
Pin layout(Male)					

ANGLE TOLERANCE	PROJECTION	Description:	Solenoid Valve
$\pm 3^{\circ}$			Valve Plug, Base Conn, Type A, Circular
GENERAL TOLERANCE	UNITS	mm	KLS P/N:
x.x $\pm 0.30$	SHEET SIZE	A4	xx
x.xx $\pm 0.20$	Draw:	Daniel	2023-06-27
x.xxx $\pm 0.10$	Check:	Daniel	2023-06-27



NingBo KLS ELECTRONIC CO.,L TD.