

1
RoHS Compliance

6	7	8
REV	SYM	Revision Record
V0	KLS01256	New Version Release
		Appr. Song
		Date 2025-01-15

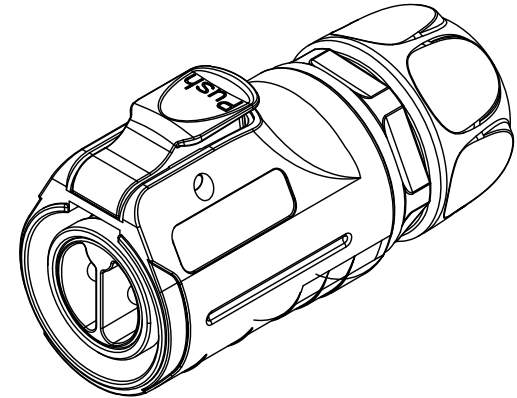
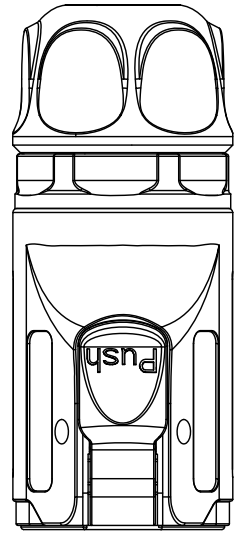

Material:
Insulation Components:
 High performance engineering plastics, UL 94V-0
Hardware: Zinc Alloy, Nickel Plating
PIN: Copper Alloy, Gold Plating
Waterproof Circle: Silica Gel

Electrical:
 Contact Resistance: 5mΩ Max
 Insulation Resistance: 500MΩ Min
 Terminal Type: Welding
 Protection Class: IP68
 Operating Cycles: 500 times Min
 Tightening Torque: 2.0N.m
 Cable OD: φ10.0 ~ φ12.0
 Operating temperature: -25°C ~ +85°C (Standard Plastic)
 -40°C ~ +85°C (Custom Plastic)

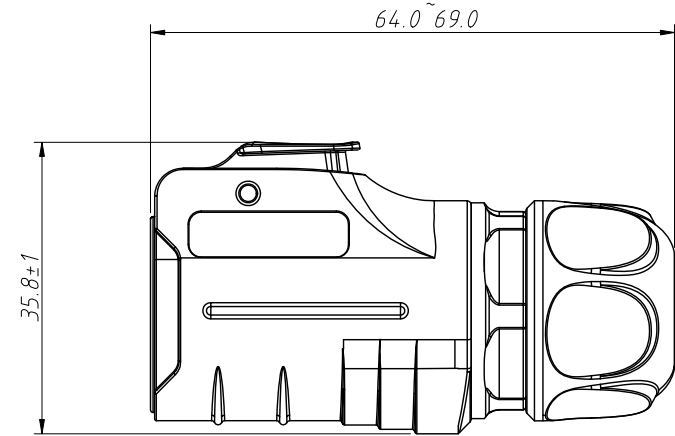
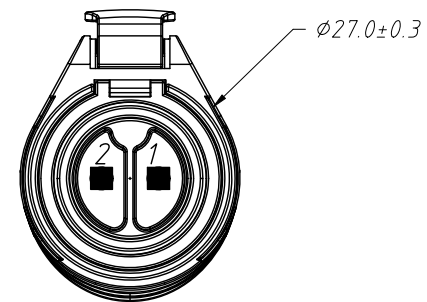

Order Information
 L-KLS15-200D-LP20-03 F2

RoHS

Number of 02 ~ 14 pins





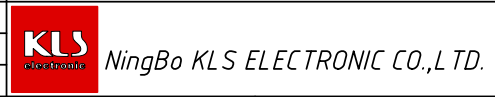













F2: Female Plug

ANGLE TOLERANCE	PROJECTION	Description:	
±3°			Metal Circular Connector
GENERAL TOLERANCE	UNITS	mm	KLS P/N: L-KLS15-200D-LP20-XXF2
.x ±0.30	SHEET SIZE	A4	1 OF 2
.xx ±0.15	Draw:	Song	2025-01-15
.xxx ±0.10	Check:	Daniel	2025-01-15





1
RoHS Compliance

6	7	8
REV	SYM	Revision Record
V0	KLS01256	New Version Release
Appr.	Song	Date
		2025-01-15

PIN NO.	02	03	04	05	07	08(6+2)	09	12	14
Male									
Female									
Rated Voltage	500V AC					250V AC	250V AC		
Rated Current	20A			10A	20A/5A	5A			
Withstand Voltage	2000VAC					1500VAC	1500VAC		
Contact Resistance	1.0m Ω			3.0m Ω	1.0m Ω / 5.0m Ω	5.0m Ω			
Insulation Resistance	500M Ω								
Wire Gauge	2.5 ~ 4.0mm ² / 14 ~ 12AWG			1.0 ~ 1.5mm ² / 18 ~ 16AWG	25 ~ 4.0mm ² / 14 ~ 12AWG 0.34 ~ 0.5mm ² / 22 ~ 20AWG	0.34 ~ 0.5mm ² / 22 ~ 20AWG			

Long Pin Long Pin

ANGLE TOLERANCE	PROJECTION	Description:
±3°		Metal Circular Connector
GENERAL TOLERANCE	UNITS	mm
.x ±0.30	SHEET SIZE	A4
.xx ±0.15	Draw:	Song
.xxx ±0.10	Check:	Daniel
		2025-01-15
		2025-01-15
		L-KLS15-200D-LP20-XXF2
		 NingBo KLS ELECTRONIC CO.,L TD.

1 RoHS Compliance

6		7		8	
REV	SYM	Revision Record		Appr.	Date
V0	KLS01256	New Version Release		Song	2025-01-15

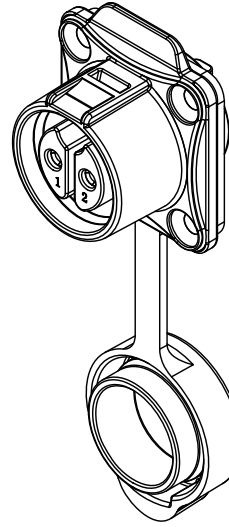
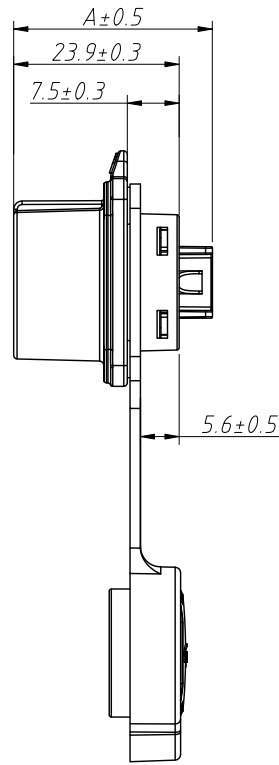
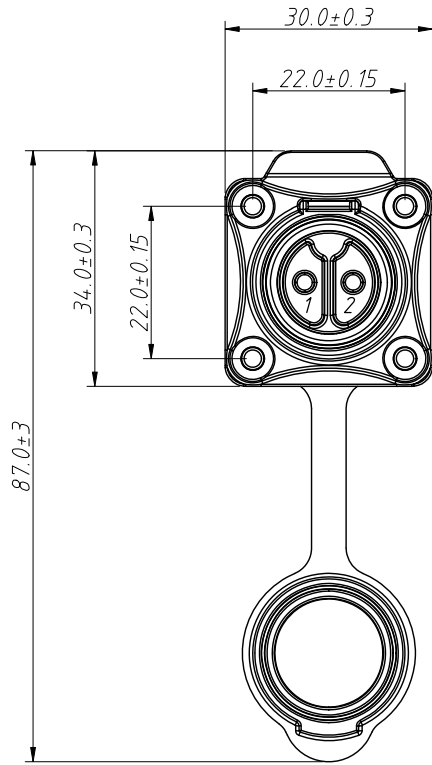

Material:

Insulation Components:

High Performance Engineering plastics, UL 94-V0

Hardware: Zinc Alloy, Nickel Plating

PIN: Copper Alloy, Gold Plating

Waterproof Circle: Silica Gel

Electrical Characteristics:

Contact Resistance: 5mΩ Max

Insulation Resistance: 500MΩ Min

Terminal Type: Welding

Protection Class: IP68

Operating Cycles: 500 times Min

Tightening torque: 0.8N.m

Operating temperature: -40°C ~ +85°C (Metal Shell)

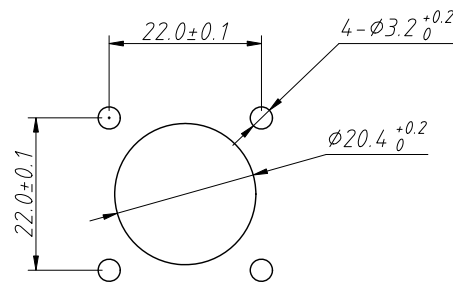

Mounting Hole Size
Mounting Screw Size: M3

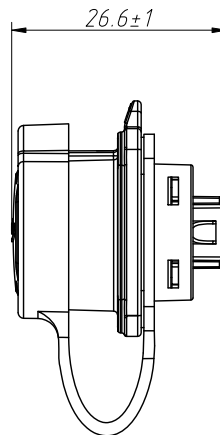

Order Information

L-KLS15-200D-LP20-03 M2

RoHS

Number of 02 ~ 14 pins

M2: Male Socket

ANGLE TOLERANCE	PROJECTION	Description:			
±3°		Metal Circular Connector			
GENERAL TOLERANCE	UNITS	mm	KLS P/N:		
.x ±0.30	SHEET SIZE	A4	L-KLS15-200D-LP20-XXM2		
.xx ±0.15	Draw:	Song	2025-01-15	NingBo KLS ELECTRONIC CO.,L TD.	
.xxx ±0.10	Check:	Daniel	2025-01-15		

1
RoHS Compliance

2

3

4

5

6

7

8

REV	SYM	Revision Record	Appr.	Date
V0	KLS01256	New Version Release	Song	2025-01-15

Long Pin Long Pin

PIN NO.	02	03	04	05	07	06+02	09	12	14
Male									
Female									
Rated Voltage	500V AC					250V AC	250V AC		
Rated Current	20A			10A		20A/5A	5A		
Withstand Voltage	2000VAC					1500VAC	1500VAC		
Contact Resistance	1.0m Ω			3.0m Ω		1.0m Ω / 5.0m Ω	5.0m Ω		
Insulation Resistance	500M Ω								
Wire Gauge	2.5 ~ 4.0mm ² / 14 ~ 12AWG			1.0 ~ 1.5mm ² / 18 ~ 16AWG		25 ~ 4.0mm ² / 14 ~ 12AWG 0.34 ~ 0.5mm ² / 22 ~ 20AWG	0.34 ~ 0.5mm ² / 22 ~ 20AWG		
Female A	28.8	28.8	29.0	27.6	26.1	29.3	27.3	27.3	26.9
Male A	29.8	29.8	29.8	28.3	26.8	29.8	26.3	26.3	27.6

ANGLE TOLERANCE	PROJECTION	Description:	Metal Circular Connector	
±3°				
GENERAL TOLERANCE	UNITS	mm	KLS P/N:	L-KLS15-200D-LP20-XXM2
.x ±0.30	SHEET SIZE	A4	2 OF 2	
.xx ±0.15	Draw:	Song	2025-01-15	
.xxx ±0.10	Check:	Daniel	2025-01-15	

NingBo KLS ELECTRONIC CO.,L TD.