

1
RoHS Compliance

The Size Of The Connector After Assembling The Cable

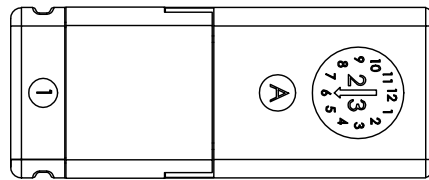

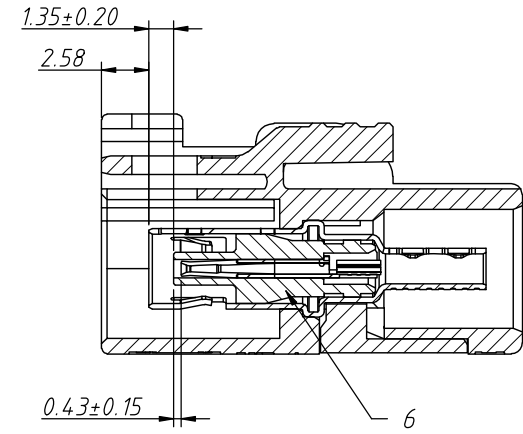

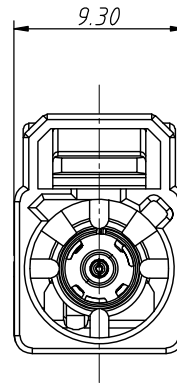
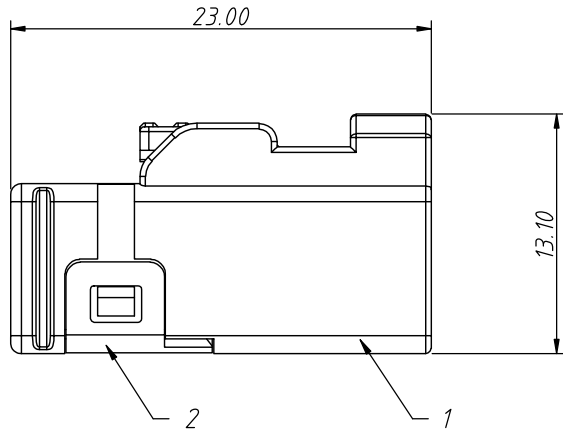
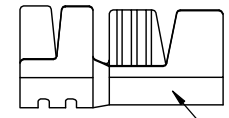
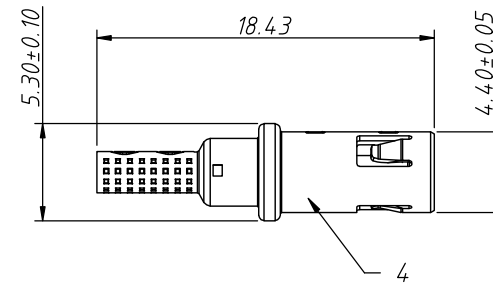
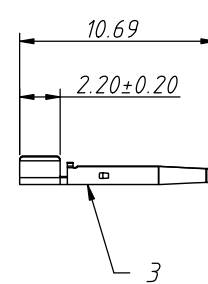











Components completed in the factory



ANGLE TOLERANCE	PROJECTION	Description:		Fakra Jack Connector
±3°				RG174, RG316 For Crimping
GENERAL TOLERANCE	UNITS	mm	KLS P/N:	L-KLS1-FAKRA49-A-XXXX-1
.x ±0.30	SHEET SIZE	A4	1 OF 2	NingBo KLS ELECTRONIC CO.,L TD.
.xx ±0.20	Draw:	Song	2024-08-12	
.xxx ±0.10	Check:	Daniel	2024-08-12	

1
RoHS Compliance

Card slot direction	Code	Color	RAL	Order Information
	A	Black	sim.9005	FAKRA49-A-9005-1
	B	White	sim.9001	FAKRA49-A-9001-1
	C	Blue	sim.5005	FAKRA49-A-5005-1
	D	Bordeaux	sim.4004	FAKRA49-A-4004-1
	E	Green	sim.6002	FAKRA49-A-6002-1
	F	Brown	sim.8011	FAKRA49-A-8011-1
	G	Grey	sim.7031	FAKRA49-A-7031-1
	H	Violet	sim.4003	FAKRA49-A-4003-1
	I	Beige	sim.1001	FAKRA49-A-1001-1
	K	Curry	sim.1027	FAKRA49-A-1027-1
	L	Carmin	sim.3002	FAKRA49-A-3002-1
	M	Pastelorange	sim.2003	FAKRA49-A-2003-1
	N	Pastel Green	sim.6019	FAKRA49-A-6019-1
	Z	Waterblue	sim.5021	FAKRA49-A-5021-1

Material:
 1.Housing:PA66
 2.Lock:PA66
 3.Terminal:Copper Alloy,Au Plated
 4.Outer conductor:Copper Alloy,Ni Plated
 5.Wire clamp:Copper alloy,Ni Plated
 6.Insulator:LCP

Electrical:
 Contact Resistance:50mOHM Max
 VSWR:0-6GHz 1.58Max
 Rating Voltage:60V/DC
 Rating Current:1A/PIN
 Insulation Resistance:1000M0HM Min
 Mating Cycles:25 Times Min
 Operation Temperature::-4.0°C ~ +105°C

Notes:
 Part 3.4.5 is assembled together and the other parts are individually packaged

Order Information
 L-KLS1-FAKRA49-A-9005-1

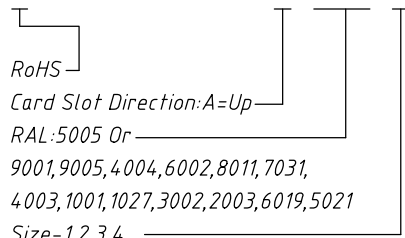

RoHS
 Card Slot Direction:A=Up
 RAL:5005 Or
 9001,9005,4004,6002,8011,7031,
 4003,1001,1027,3002,2003,6019,5021
 Size-1,2,3,4...

ANGLE TOLERANCE	PROJECTION	Description:	Fakra Jack Connector
±3°			RG174, RG316 For Crimping
GENERAL TOLERANCE	UNITS	mm	KLS P/N:
.x ±0.30	SHEET SIZE	A4	L-KLS1-FAKRA49-A-XXXX-1
.xx ±0.20	Draw:	Song	2024-08-12
.xxx ±0.10	Check:	Daniel	2024-08-12



NingBo KLS ELECTRONIC CO.,L TD.