

1
RoHS Compliance

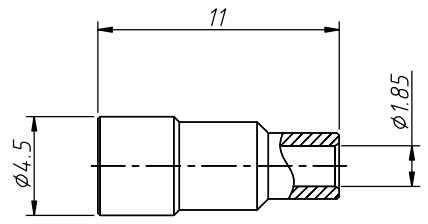

Copper tube

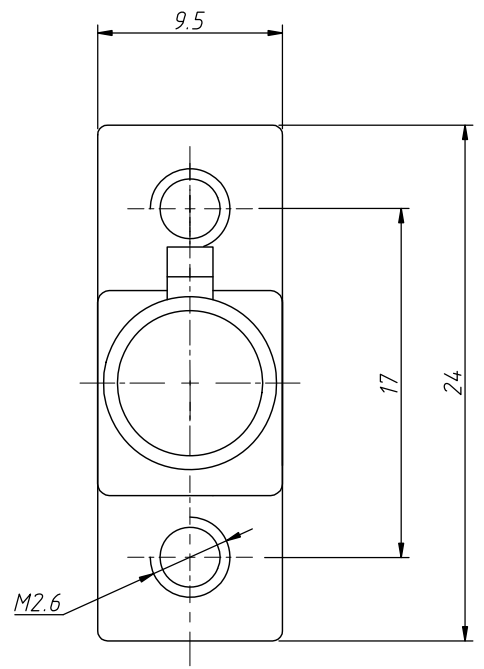
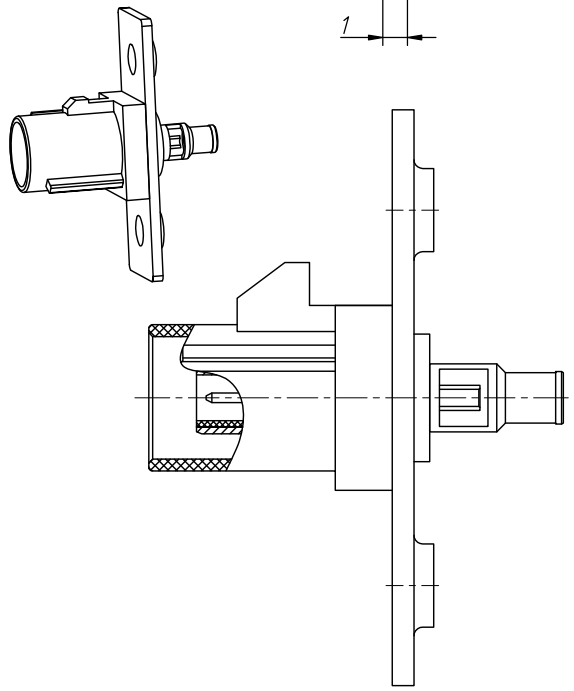
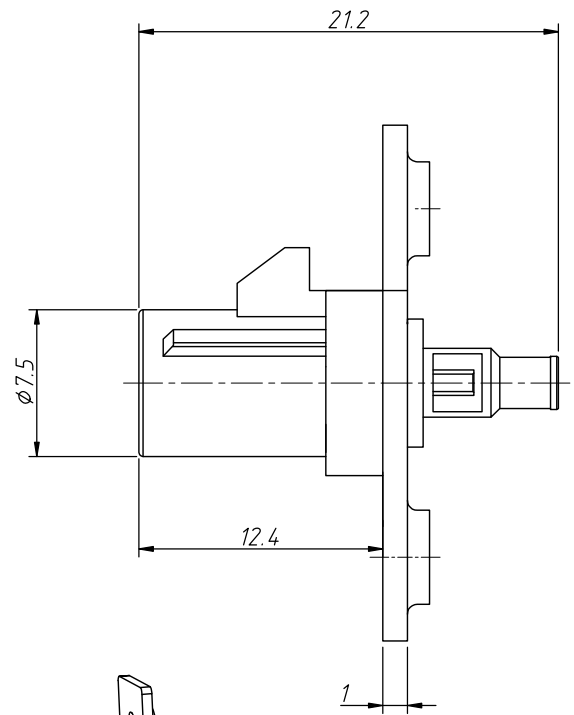
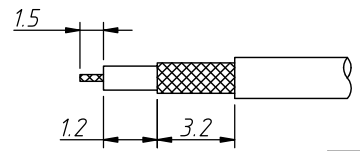

Cable stripping size

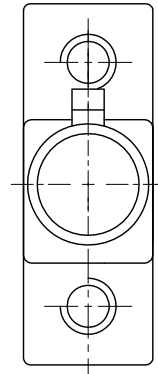

A=up

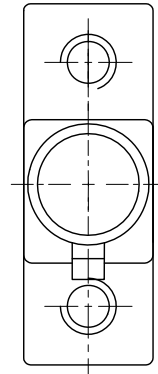

B=down

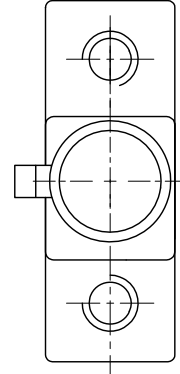



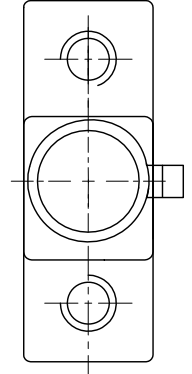











C=Left



D=Right

ANGLE TOLERANCE	PROJECTION	Description:		
±3°		FAKRA Plug Connector Crimp For RG174, RG316		
GENERAL TOLERANCE	UNITS	mm	KLS P/N:	L-KLS1-FAKRA39-X-XXXX-1
x. ±0.30	SHEET SIZE	A4	1 Of 2	NingBo KLS ELECTRONIC CO.,L TD.
x.x ±0.25	Draw:	Daniel	2024-08-02	
x.xx ±0.20	Check:	Daniel	2024-08-02	

1
RoHS Compliance

Card slot direction	Code	Color	RAL	Order Information
	A	Black	sim.9005	FAKRA37-A-9005-1
	B	White	sim.9001	FAKRA37-A-9001-1
	C	Blue	sim.5005	FAKRA37-A-5005-1
	D	Bordeaux Violet	sim.4004	FAKRA37-A-4004-1
	E	Green	sim.6002	FAKRA37-A-6002-1
	F	Brown	sim.8011	FAKRA37-A-8011-1
	G	Grey	sim.7031	FAKRA37-A-7031-1
	H	Violet	sim.4003	FAKRA37-A-4003-1
	I	Beige	sim.1001	FAKRA37-A-1001-1
	K	Curry	sim.1027	FAKRA37-A-1027-1
	L	Carmine Red	sim.3002	FAKRA37-A-3002-1
	M	Pastel orange	sim.2003	FAKRA37-A-2003-1
	N	Pastel Green	sim.6019	FAKRA37-A-6019-1
	Z	Water Blue	sim.5021	FAKRA37-A-5021-1

Material:
Pin:Brass,Gold Plated
Mounting Plate:Steel
Insulator: PTFE
Body: Brass
Housing: PA66 GF30

Electrical:
Contact Resistance: 50mOHM Max
Frequency Range: DC to 4 GHz
VSWR:0-6GHz 1.58Max
Rating Voltage:60V/DC
Rating Current:1A/PIN
Insulation Resistance:1000M0HM Min
Mating Cycles:25 Times Min
Operation Temperature::-40°C ~ +105°C

Order Information
L-KLS1-FAKRA39-A-9005-1

RoHS

Card Slot Direction: _____
A=up B=down C=Left D=Right

RAL: _____
9005 Or 9001,5005,4004,6002,8011,7031,
4003,1001,1027,3002,2003,6019,5021
Size-1,2,3,4... _____

ANGLE TOLERANCE	PROJECTION	Description:	FAKRA Plug Connector Crimp For RG174, RG316
±3°			
GENERAL TOLERANCE	UNITS	mm	KLS P/N: L-KLS1-FAKRA39-X-XXXX-1
x. ±0.30	SHEET SIZE	A4	2 Of 2
x.x ±0.25	Draw:	Daniel	2024-08-02
x.xx ±0.20	Check:	Daniel	2024-08-02



NingBo KLS ELECTRONIC CO.,L TD.