

1
RoHS Compliance

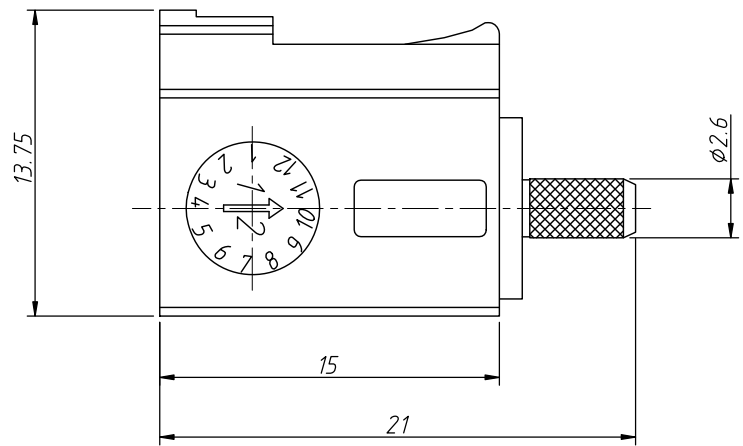

Plastic Housing

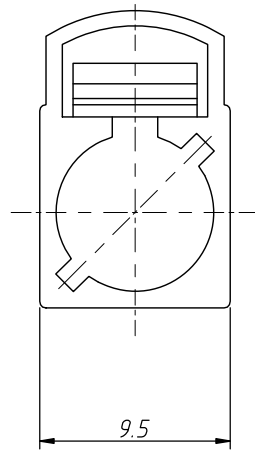

FAKRA C Jack

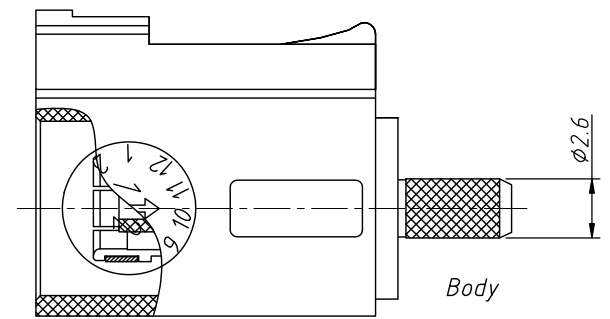

Body

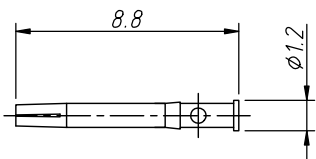

Pin Contact

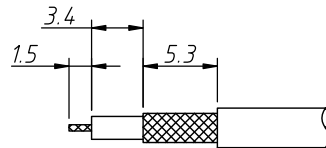

Cable Stripping Size

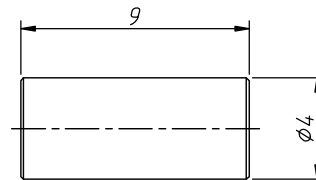

Copper Tube

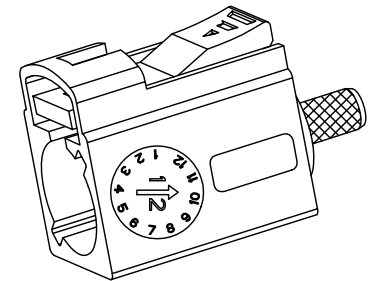

ANGLE TOLERANCE	PROJECTION	Description:	Fakra jack connector RG174, RG316 RG58 For Crimping	
±3°			L-KLS1-FAKRA42-A-XXXX-1	
GENERAL TOLERANCE	UNITS	mm	KLS P/N:	
x.x ±0.30	SHEET SIZE	A4	1 OF 2	
x.xx ±0.20	Draw:	Daniel	2024-06-06	
x.xxx ±0.03	Check:	Daniel	2024-06-06	

NingBo KLS ELECTRONIC CO.,L TD.

1
RoHS Compliance

Card slot direction	Code	Color	RAL	Order Information
	A	Black	sim.9005	FAKRA42-A-9005-1
	B	White	sim.9001	FAKRA42-A-9001-1
	C	Blue	sim.5005	FAKRA42-A-5005-1
	D	Bordeaux Violet	sim.4004	FAKRA42-A-4004-1
	E	Green	sim.6002	FAKRA42-A-6002-1
	F	Brown	sim.8011	FAKRA42-A-8011-1
	G	Grey	sim.7031	FAKRA42-A-7031-1
	H	Violet	sim.4003	FAKRA42-A-4003-1
	I	Beige	sim.1001	FAKRA42-A-1001-1
	K	Curry	sim.1027	FAKRA42-A-1027-1
	L	Carmin Red	sim.3002	FAKRA42-A-3002-1
	M	Pastel orange	sim.2003	FAKRA42-A-2003-1
	N	Pastel Green	sim.6019	FAKRA42-A-6019-1
	Z	Water Blue	sim.5021	FAKRA42-A-5021-1

Material:
Housing:PA66+30%GF
Body:Brass,Nickel Plating
Snap Ring:Beryllium Copper
Copper Tube:Brass,Nickel Plating
Insulator:PTFE
Pin Contact:Beryllium Copper,Gold Plating

Electrical:
Frequency Range:DC~4 GHz
Nominal Impedance:50 ohms
VSWR:<1.3
Withstanding Voltage:335 V
Insulator Resistance:1000 MΩ
Contact Resistance:6 Milliohms Max(Center Contact)
1 Milliohms Max(Outer Contact)
Operating Temperature:-40°C~+85°C
Environmental:Lead Free, RoHS compliant

Order Information
L-KLS1-FAKRA42-A-9005-1

RoHS
Card Slot Direction:
A=up
RAL:
9005 Or 9001,5005,4004,6002,8011,7031,
4003,1001,1027,3002,2003,6019,5021
Size-1,2,3,4...

ANGLE TOLERANCE	PROJECTION		Description:	Fakra jack connector RG174, RG316 RG58 For Crimping
±3°				
GENERAL TOLERANCE	UNITS	mm	KLS P/N:	L-KLS1-FAKRA42-A-XXXX-1
x.x ±0.30	SHEET SIZE	A4	2 Of 2	
x.xx ±0.20	Draw:	Daniel	2024-06-06	
x.xxx ±0.03	Check:	Daniel	2024-06-06	

NingBo KLS ELECTRONIC CO.,L TD.

1
RoHS Compliance

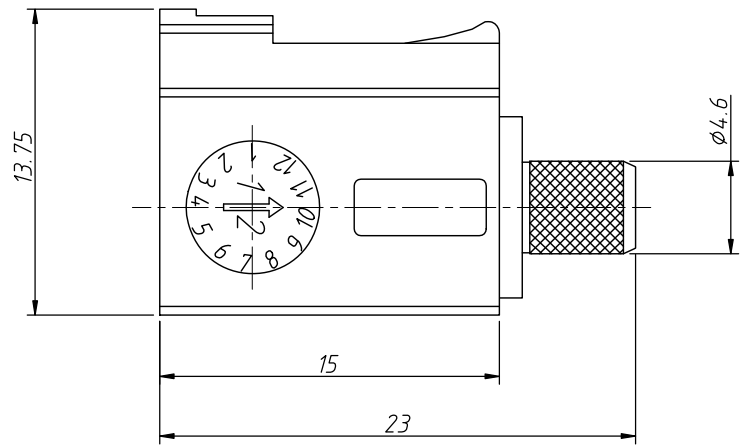

Plastic Housing

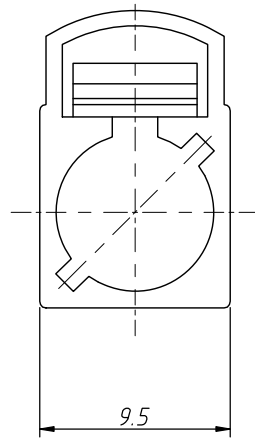

FAKRA C Jack

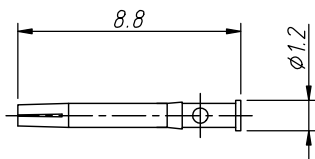
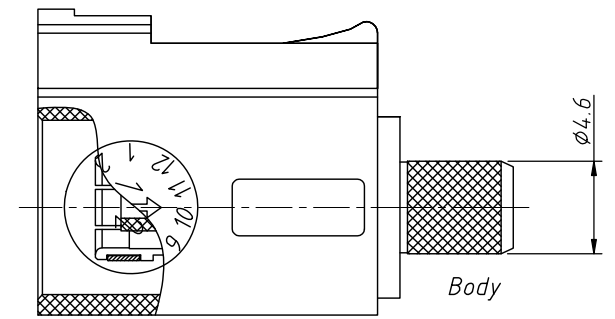

Pin Contact

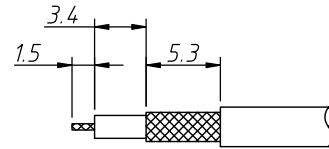

Cable Stripping Size

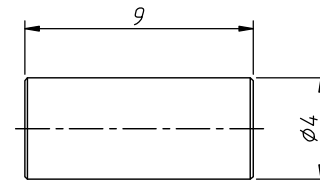

Copper Tube

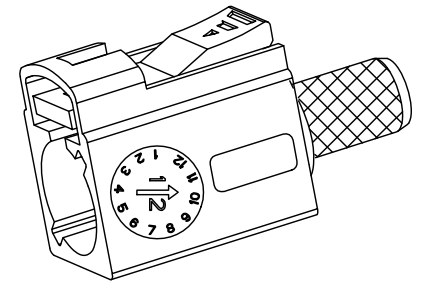

ANGLE TOLERANCE	PROJECTION	Description:		
±3°		Fakra jack connector RG174, RG316 RG58 For Crimping		
GENERAL TOLERANCE	UNITS	mm	KLS P/N:	L-KLS1-FAKRA42-A-XXXX-2
x.x ±0.30	SHEET SIZE	A4	1 OF 2	NingBo KLS ELECTRONIC CO.,L TD.
x.xx ±0.20	Draw:	Daniel	2024-06-06	
x.xxx ±0.03	Check:	Daniel	2024-06-06	

1
RoHS Compliance

Card slot direction	Code	Color	RAL	Order Information
	A	Black	sim.9005	FAKRA42-A-9005-2
	B	White	sim.9001	FAKRA42-A-9001-2
	C	Blue	sim.5005	FAKRA42-A-5005-2
	D	Bordeaux Violet	sim.4004	FAKRA42-A-4004-2
	E	Green	sim.6002	FAKRA42-A-6002-2
	F	Brown	sim.8011	FAKRA42-A-8011-2
	G	Grey	sim.7031	FAKRA42-A-7031-2
	H	Violet	sim.4003	FAKRA42-A-4003-2
	I	Beige	sim.1001	FAKRA42-A-1001-2
	K	Curry	sim.1027	FAKRA42-A-1027-2
	L	Carmin Red	sim.3002	FAKRA42-A-3002-2
	M	Pastel orange	sim.2003	FAKRA42-A-2003-2
	N	Pastel Green	sim.6019	FAKRA42-A-6019-2
	Z	Water Blue	sim.5021	FAKRA42-A-5021-2

Material:
Housing:PA66+30%GF
Body:Brass,Nickel Plating
Snap Ring:Beryllium Copper
Copper Tube:Brass,Nickel Plating
Insulator:PTFE
Pin Contact:Beryllium Copper,Gold Plating

Electrical:
Frequency Range:DC~4 GHz
Nominal Impedance:50 ohms
VSWR:<1.3
Withstanding Voltage:335 V
Insulator Resistance:1000 MΩ
Contact Resistance:6 Milliohms Max(Center Contact)
1 Milliohms Max(Outer Contact)
Operating Temperature:-40°C~+85°C
Environmental:Lead Free, RoHS compliant

Order Information
L-KLS1-FAKRA42-A-9005-2

RoHS
Card Slot Direction:
A=up
RAL:
9005 Or 9001,5005,4004,6002,8011,7031,
4003,1001,1027,3002,2003,6019,5021
Size-1,2,3,4...

ANGLE TOLERANCE	PROJECTION	Description:	Fakra jack connector RG174, RG316 RG58 For Crimping
±3°			
GENERAL TOLERANCE	UNITS	mm	KLS P/N: L-KLS1-FAKRA42-A-XXXX-2
x.x ±0.30	SHEET SIZE	A4	2 Of 2
x.xx ±0.20	Draw:	Daniel	2024-06-06
x.xxx ±0.03	Check:	Daniel	2024-06-06

NingBo KLS ELECTRONIC CO.,L TD.

1
RoHS Compliance

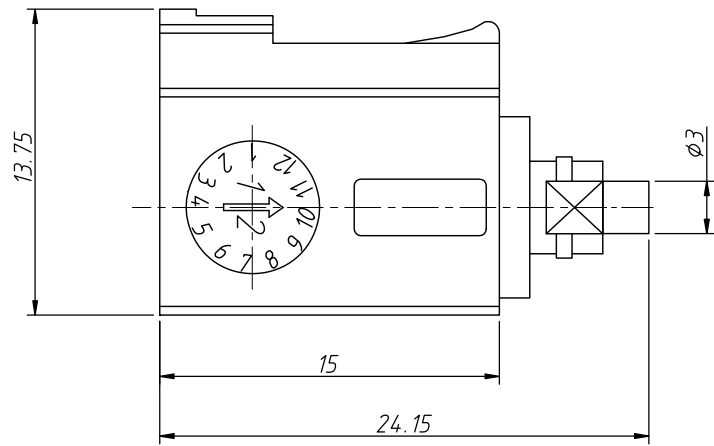

Plastic Housing

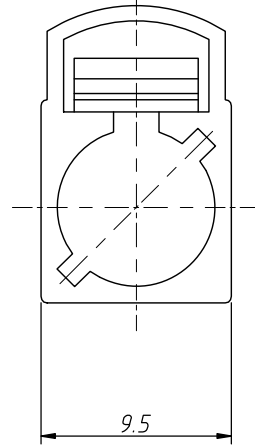

FAKRA C Jack

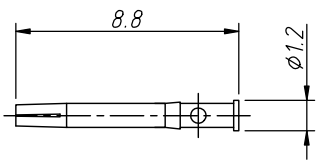
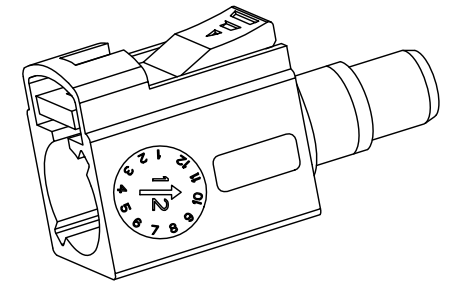
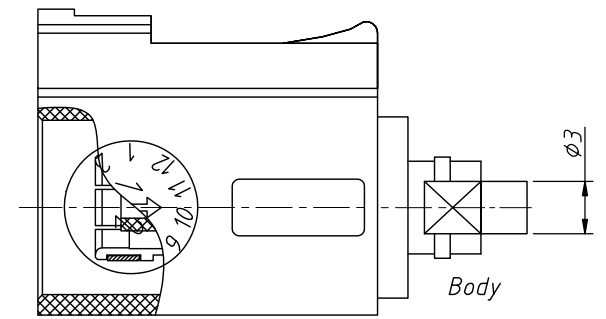

Pin Contact

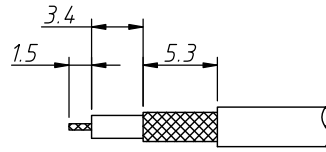

Cable Stripping Size

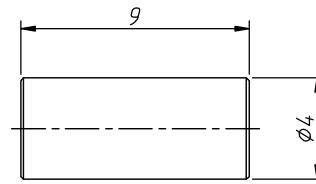

Copper Tube

ANGLE TOLERANCE	PROJECTION	Description:	
±3°		Fakra jack connector RG174, RG316 RG58 For Crimping	
GENERAL TOLERANCE	UNITS	mm	KLS P/N:
x.x ±0.30	SHEET SIZE	A4	1 OF 2
x.xx ±0.20	Draw:	Daniel	2024-06-06
x.xxx ±0.03	Check:	Daniel	2024-06-06



NingBo KLS ELECTRONIC CO.,L TD.

1
RoHS Compliance

Card slot direction	Code	Color	RAL	Order Information
	A	Black	sim.9005	FAKRA42-A-9005-3
	B	White	sim.9001	FAKRA42-A-9001-3
	C	Blue	sim.5005	FAKRA42-A-5005-3
	D	Bordeaux Violet	sim.4004	FAKRA42-A-4004-3
	E	Green	sim.6002	FAKRA42-A-6002-3
	F	Brown	sim.8011	FAKRA42-A-8011-3
	G	Grey	sim.7031	FAKRA42-A-7031-3
	H	Violet	sim.4003	FAKRA42-A-4003-3
	I	Beige	sim.1001	FAKRA42-A-1001-3
	K	Curry	sim.1027	FAKRA42-A-1027-3
	L	Carmin Red	sim.3002	FAKRA42-A-3002-3
	M	Pastel orange	sim.2003	FAKRA42-A-2003-3
	N	Pastel Green	sim.6019	FAKRA42-A-6019-3
	Z	Water Blue	sim.5021	FAKRA42-A-5021-3

Material:
 Housing:PA66+30%GF
 Body:Brass,Nickel Plating
 Snap Ring:Beryllium Copper
 Copper Tube:Brass,Nickel Plating
 Insulator:PTFE
 Pin Contact:Beryllium Copper,Gold Plating

Electrical:
 Frequency Range:DC~4 GHz
 Nominal Impedance:50 ohms
 VSWR:<1.3
 Withstanding Voltage:335 V
 Insulator Resistance:1000 MΩ
 Contact Resistance:6 Milliohms Max(Center Contact)
 1 Milliohms Max(Outer Contact)
 Operating Temperature:-40°C~+85°C
 Environmental:Lead Free, RoHS compliant

Order Information
 L-KLS1-FAKRA42-A-9005-3

RoHS

Card Slot Direction:

A=up

RAL:

9005 Or 9001,5005,4004,6002,8011,7031,
 4003,1001,1027,3002,2003,6019,5021

Size-1,2,3,4...

ANGLE TOLERANCE	PROJECTION	Description:	Fakra jack connector RG174, RG316 RG58 For Crimping
±3°			
GENERAL TOLERANCE	UNITS	mm	KLS P/N: L-KLS1-FAKRA42-A-XXXX-3
x.x ±0.30	SHEET SIZE	A4	2 Of 2
x.xx ±0.20	Draw:	Daniel	2024-06-06
x.xxx ±0.03	Check:	Daniel	2024-06-06



NingBo KLS ELECTRONIC CO.,L TD.

1
RoHS Compliance

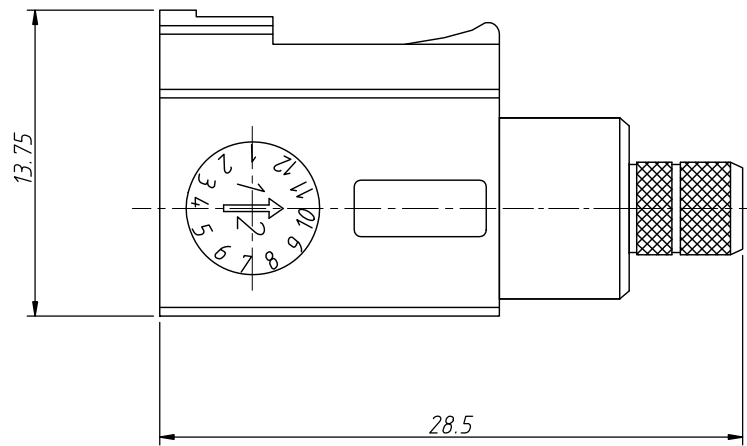

Plastic Housing

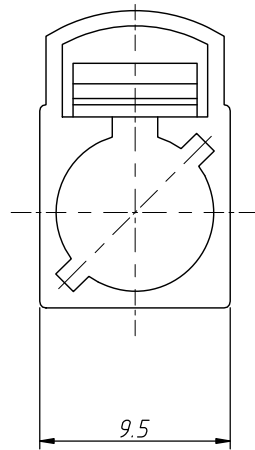

FAKRA C Jack

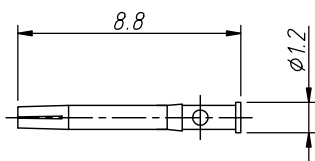
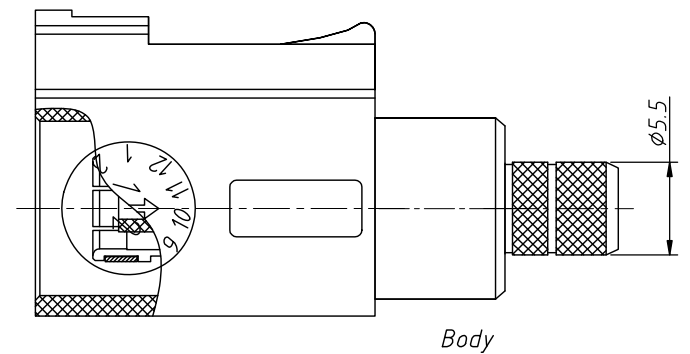

Pin Contact

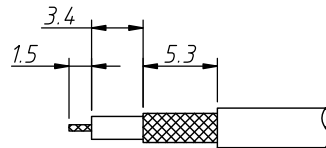

Cable Stripping Size

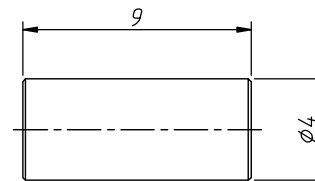

Copper Tube

ANGLE TOLERANCE	PROJECTION	Description:	Fakra jack connector RG174, RG316 RG58 For Crimping	
±3°				
GENERAL TOLERANCE	UNITS	mm	KLS P/N:	L-KLS1-FAKRA42-A-XXXX-4
x.x ±0.30	SHEET SIZE	A4	1 OF 2	
x.xx ±0.20	Draw:	Daniel	2024-06-06	
x.xxx ±0.03	Check:	Daniel	2024-06-06	

NingBo KLS ELECTRONIC CO.,L TD.

1
RoHS Compliance

Card slot direction	Code	Color	RAL	Order Information
	A	Black	sim.9005	FAKRA42-A-9005-4
	B	White	sim.9001	FAKRA42-A-9001-4
	C	Blue	sim.5005	FAKRA42-A-5005-4
	D	Bordeaux Violet	sim.4004	FAKRA42-A-4004-4
	E	Green	sim.6002	FAKRA42-A-6002-4
	F	Brown	sim.8011	FAKRA42-A-8011-4
	G	Grey	sim.7031	FAKRA42-A-7031-4
	H	Violet	sim.4003	FAKRA42-A-4003-4
	I	Beige	sim.1001	FAKRA42-A-1001-4
	J	Curry	sim.1027	FAKRA42-A-1027-4
	K	Carmin Red	sim.3002	FAKRA42-A-3002-4
	L	Pastel orange	sim.2003	FAKRA42-A-2003-4
	M	Pastel Green	sim.6019	FAKRA42-A-6019-4
	N	Pastel Green	sim.6019	FAKRA42-A-6019-4
	O	Water Blue	sim.5021	FAKRA42-A-5021-4

Material:
 Housing:PA66+30%GF
 Body:Brass,Nickel Plating
 Snap Ring:Beryllium Copper
 Copper Tube:Brass,Nickel Plating
 Insulator:PTFE
 Pin Contact:Beryllium Copper,Gold Plating

Electrical:
 Frequency Range:DC~4 GHz
 Nominal Impedance:50 ohms
 VSWR:<1.3
 Withstanding Voltage:335 V
 Insulator Resistance:1000 MΩ
 Contact Resistance:6 Milliohms Max(Center Contact)
 1 Milliohms Max(Outer Contact)
 Operating Temperature:-40°C~+85°C
 Environmental:Lead Free, RoHS compliant

Order Information
 L-KLS1-FAKRA42-A-9005-4

RoHS
 Card Slot Direction:
 A=up
 RAL:
 9005 Or 9001,5005,4004,6002,8011,7031,
 4003,1001,1027,3002,2003,6019,5021
 Size-1,2,3,4...

ANGLE TOLERANCE	PROJECTION	Description:	Fakra jack connector RG174, RG316 RG58 For Crimping
±3°			
GENERAL TOLERANCE	UNITS	mm	KLS P/N: L-KLS1-FAKRA42-A-XXXX-4
x.x ±0.30	SHEET SIZE	A4	2 Of 2
x.xx ±0.20	Draw:	Daniel	2024-06-06
x.xxx ±0.03	Check:	Daniel	2024-06-06

NingBo KLS ELECTRONIC CO.,L TD.