

RoHS Compliance

REV	SYM	Revision Record	Appr.	Date
V0	KLS02006	New Version Release	Song	2024-10-22

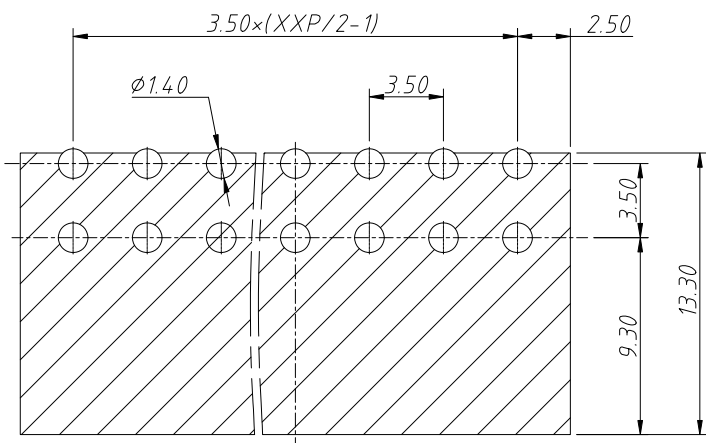

Recommended PCB Layout

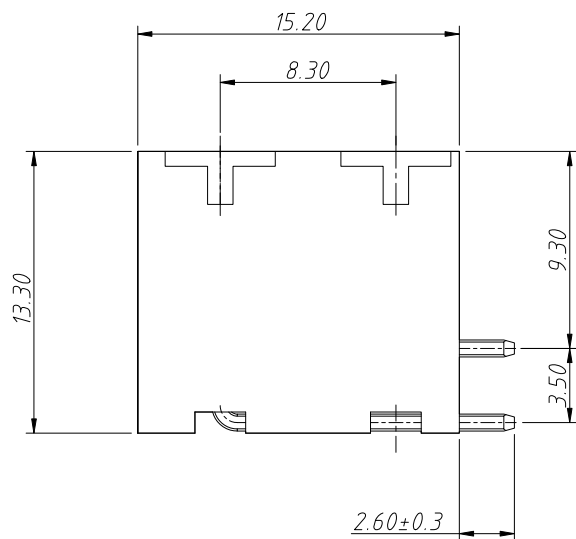
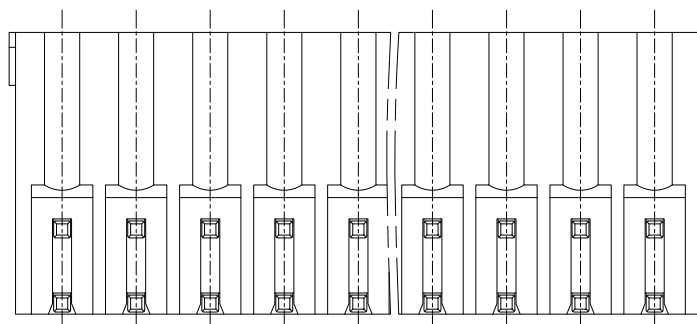
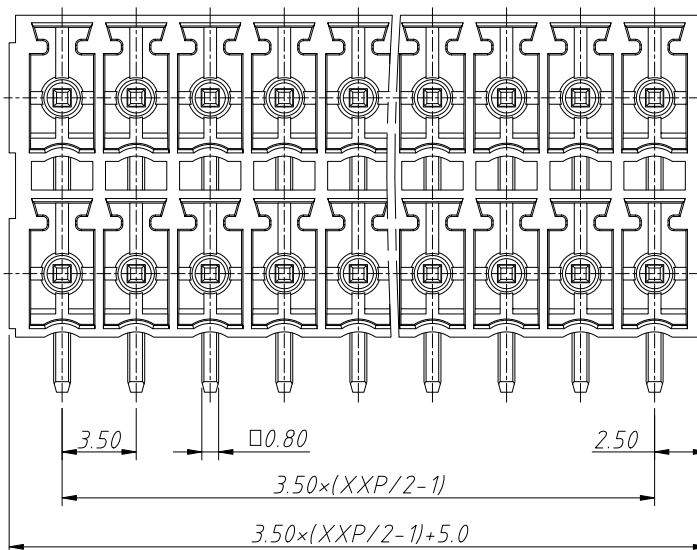

Electrical Characteristics	UL	IEC
Rated Voltage	300V	160V
Rated Current	8A	8A
Withstand Voltage	1600V / 1min	2.5KV

Material and other:

Housing: LCP, UL94V-0

Pin: Copper Alloy, Sn Plated

Operating Temperature: -40°C ~ +130°C

Soldering Temperature: 285°C / 10S

Order Information

L-KLS2-THREDRH-3.50-XXP-3

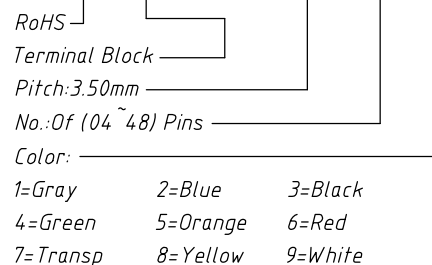

ANGLE TOLERANCE	PROJECTION	Description:
±3°		Pitch 3.50mm Pluggable Terminal Block, Socket
GENERAL TOLERANCE	UNITS	mm
0 ~ 30	±0.50	SHEET SIZE
30 ~ 60	±0.75	Draw:
60 ~ 90	±1.00	Check:
		KLS P/N:
		L-KLS2-THREDRH-3.50-XXP-X
		2024-10-22
		2024-10-22



NingBo KLS ELECTRONIC CO.,LTD.

1 RoHS Compliance

REV	SYM	Revision Record	Appr.	Date
V0	KLS02006	New Version Release	WuHao	2024-10-8

Electrical Characteristics	UL	IEC
Rated Voltage	300V	160V
Rated Current	8A	8A
Withstand Voltage	1600V/1 min	2.5KV

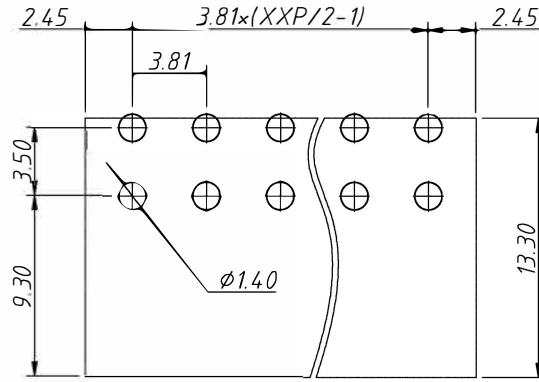
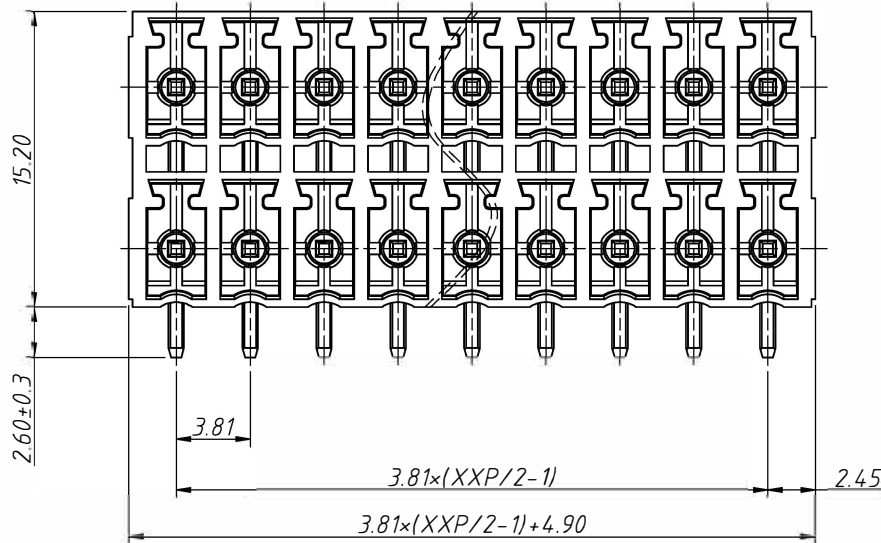

Recommended PCB Layout

Material and other:
 Housing:LCP UL 94V-0
 Pin Header:Copper Alloy,Sn Plated
 Operating Temperature:-40°C ~ +130°C
 Soldering Temperature:285°C/10 Sec

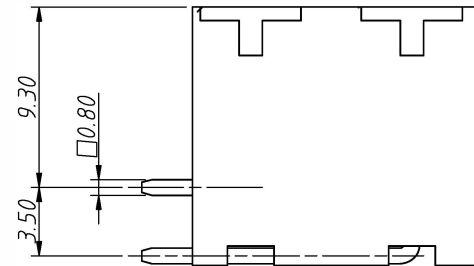
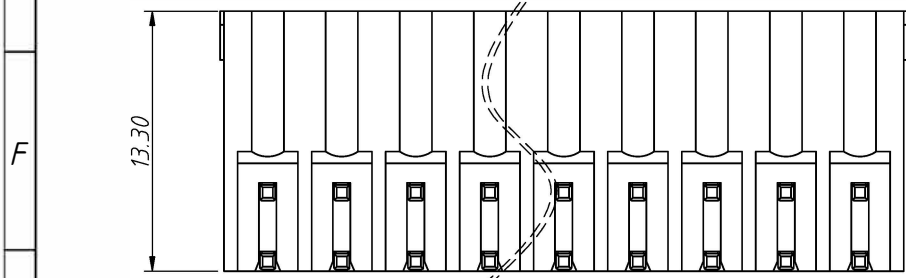

Order Information

L-KLS2-THREDRH-3.81-XXP-X

RoHS
 Terminal Block
 Pitch:3.81mm
 No.:Of (04~48) Pin
 Color:
 1=Gray 2=Blue 3=Black
 4=Green 5=Orange 6=Red
 7=Transp 8=Yellow 9=White

ANGLE TOLERANCE	PROJECTION	Description:
±3°		Pitch 3.81mm Pluggable Terminal Block,Socket
GENERAL TOLERANCE	UNITS	mm
0°~30° ±0.50	SHEET SIZE	A4
30°~60° ±0.75	Draw:	WuHao 2024-10-8
60°~90° ±1.00	Check:	Daniel 2024-10-8
		L-KLS2-THREDRH-3.81-XXP-X
		NingBo KLS ELECTRONIC CO.,L TD.