

1 RoHS Compliance

6	7	8
REV	SYM	Revision Record
V0	KLS12031	New Version Release
		Appr. Song
		Date 2024-08-13

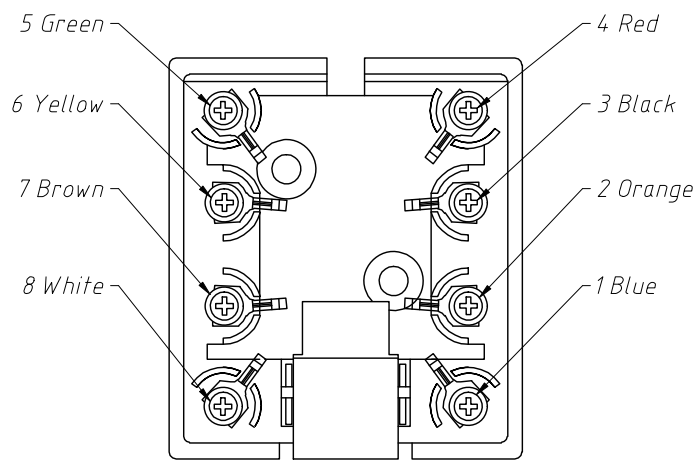
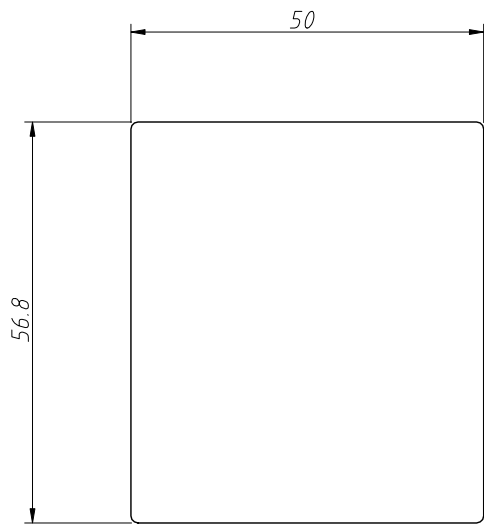

Material:  
 Pin: Brass, Fu" Gold Plating  
 Terminal: Brass  
 Support: ABS, Ivory  
 Housing: ABS, Ivory  
 Wire: UL 7×0.11×1.05, L=60mm  
 Screw: 8PCS+2PCS(standby)  
 Duplex Glue: 4.0×50×1.5

Move Cover

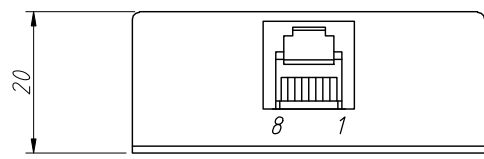

US JACK 8P8C

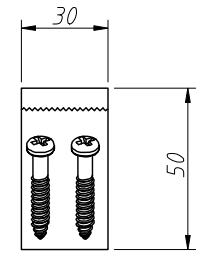
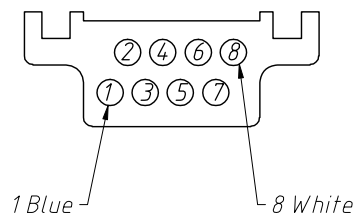
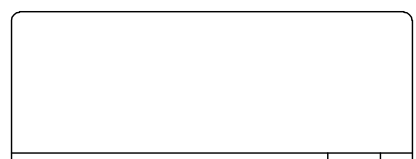

Add SCREW:(M3×14), 2PCS

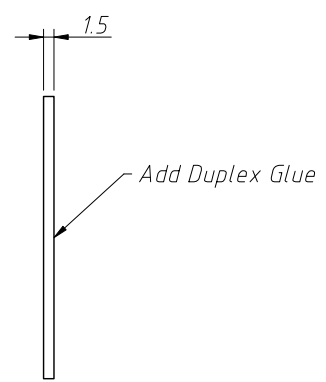
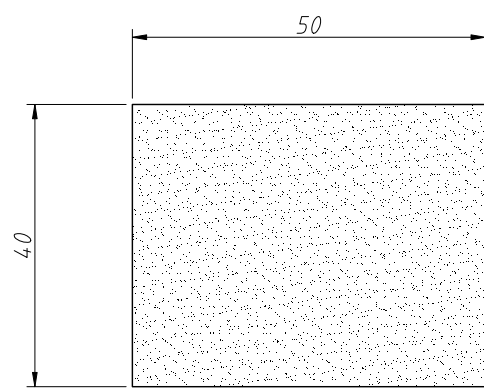

Add Duplex Glue

ANGLE TOLERANCE	PROJECTION	Description:	Telephone Splitter Box, 8P8C
±3°			Single RJ45 Jack To Single RJ45 Jack
GENERAL TOLERANCE	UNITS	mm	KLS P/N: L-KLS12-188-8P8C-I-01
.x ±0.30	SHEET SIZE	A4	NingBo KLS ELECTRONIC CO.,L TD.
.xx ±0.20	Draw:	Song	
.xxx ±0.10	Check:	Daniel	



NingBo KLS ELECTRONIC CO.,L TD.