

1
RoHS Compliance

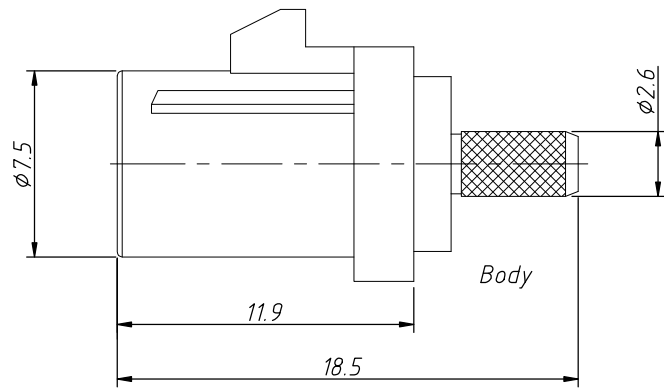

Plastic Shell

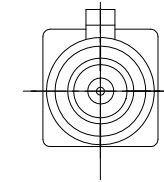
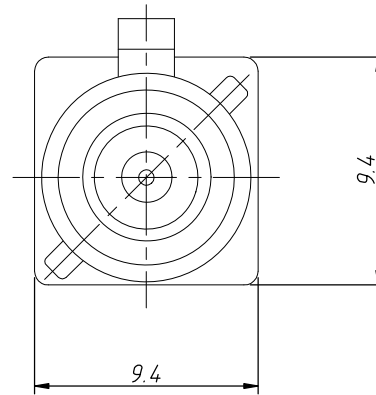

A=up

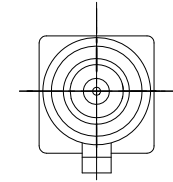

B=down

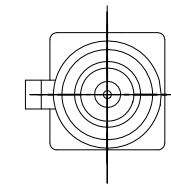

C=Left

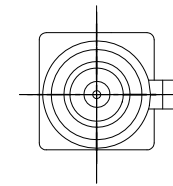

D=Right

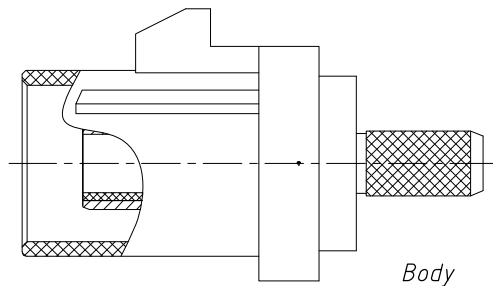

Plastic Shell

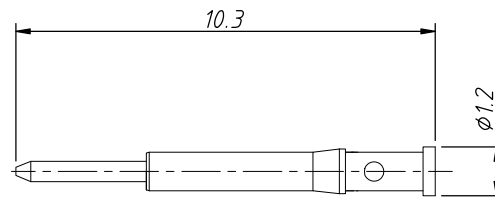

Pin Contact

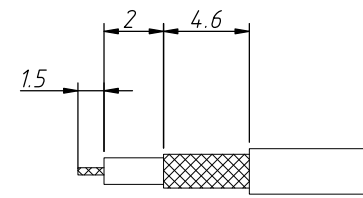

Cable Stripping Size

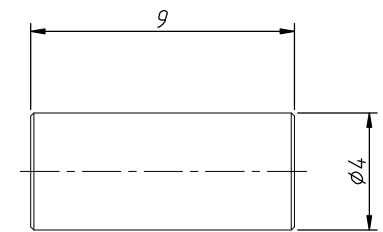

Copper Tube

ANGLE TOLERANCE	PROJECTION	Description:		
±3°		FAKRA Crimp Plug Connector		
GENERAL TOLERANCE	UNITS	mm	KLS P/N:	L-KLS1-FAKRA35-X-XXXX-1
x.x ±0.30	SHEET SIZE	A4	1 OF 2	NingBo KLS ELECTRONIC CO.,L TD.
x.xx ±0.20	Draw:	Daniel	2024-06-06	
x.xxx ±0.03	Check:	Daniel	2024-06-06	

1
RoHS Compliance

Card slot direction	Code	Color	RAL	Order Information
	A	Black	sim.9005	FAKRA35-A-9005-1
	B	White	sim.9001	FAKRA35-A-9001-1
	C	Blue	sim.5005	FAKRA35-A-5005-1
	D	Bordeaux Violet	sim.4004	FAKRA35-A-4004-1
	E	Green	sim.6002	FAKRA35-A-6002-1
	F	Brown	sim.8011	FAKRA35-A-8011-1
	G	Grey	sim.7031	FAKRA35-A-7031-1
	H	Violet	sim.4003	FAKRA35-A-4003-1
	I	Beige	sim.1001	FAKRA35-A-1001-1
	K	Curry	sim.1027	FAKRA35-A-1027-1
	L	Carmine Red	sim.3002	FAKRA35-A-3002-1
	M	Pastel orange	sim.2003	FAKRA35-A-2003-1
	N	Pastel Green	sim.6019	FAKRA35-A-6019-1
	Z	Water Blue	sim.5021	FAKRA35-A-5021-1

Material:
Housing:PA66+30%GF
Copper Tube:Brass,Nickel Plating
Insulator:PTFE
Pin Contact:Brass,Gold Plating
Body:Brass,Nickel Plating

Electrical:
Frequency Range:DC ~ 4 GHz
Nominal Impedance:50 ohms
Withstanding Voltage:335 V
Insulator Resistance:1000 MΩ
Contact Resistance:6 Milliohms Max(Center Contact)
1 Milliohms Max(Outer Contact)
Operating Temperature:-40°C ~ +85°C
Environmental:Lead Free, RoHS compliant

Order Information
L-KLS1-FAKRA35-A-9005-1

RoHS
Card Slot Direction:
A=up B=down C=Left D=Right
RAL:
9005 Or 9001,5005,4004,6002,8011,7031,
4003,1001,1027,3002,2003,6019,5021
Size-1,2,3,4...

ANGLE TOLERANCE	PROJECTION	Description:	FAKRA Crimp Plug Connector		
±3°					
GENERAL TOLERANCE	UNITS	mm	KLS P/N:	L-KLS1-FAKRA35-X-XXXX-1	
x.x ±0.30	SHEET SIZE	A4	2 Of 2		
x.xx ±0.20	Draw:	Daniel	2024-06-06		
x.xxx ±0.03	Check:	Daniel	2024-06-06		

