

Film

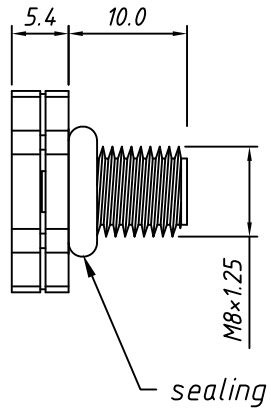

sealing

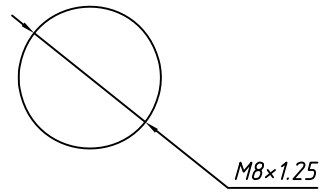
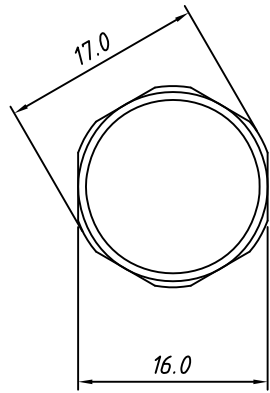

M8x1.25

Panel Mounting
hole diameter

Material
 Material: PC
 Film: EPTFE
 Sealing: NBR, EPDM
 IP rating: IP67
 Thread: M8x1.0
 Panel Mounting: $\phi 12$ or M8x1.0
 Temp. Range: $-40^{\circ}\text{C} \sim +125^{\circ}\text{C}$
 breathable valve Range: 500ml/minute
 Maximum torque: 8Kgf.cm Max.

Order Information

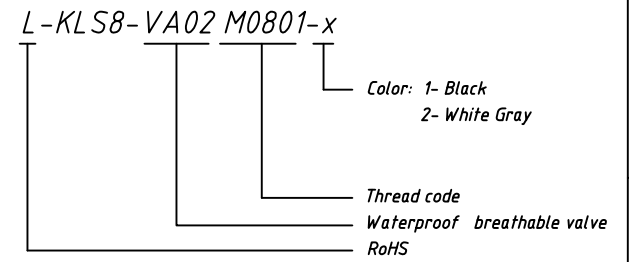

GENERAL TOLERANCE		ANGLE TOLERANCE		Description:	
X.	± 0.60	X.	$\pm 5^{\circ}$	M8x1.0 waterproof breathable valve	
.X	± 0.38	.X	$\pm 3^{\circ}$		
.XX	± 0.25	.XX	$\pm 2^{\circ}$		
Draw		2018-01-20	PROJECTION		KLS P/N: KLS8-VA02M0801-x
Check		2018-01-20	UNITS	mm	NingBo KLS ELECTRONIC CO.,L TD.
SCALE			SHEET SIZE	A4	

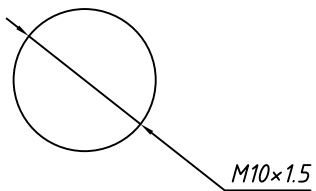
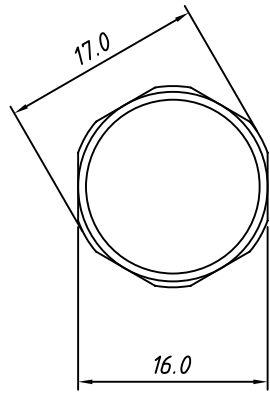
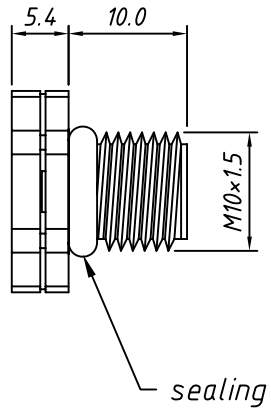
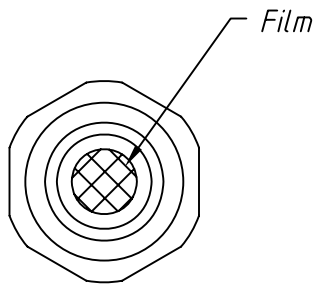

Panel Mounting
hole diameter

Material
 Material: PC
 Film: EPTFE
 Sealing: NBR, EPDM
 IP rating: IP67
 Thread: M10x1.5
 Panel Mounting: M10x1.5
 Temp. Range: -40 °C ~ + 125 °C
 breathable valve Range: 900ml/minute
 Maximum torque: 10Kgf.cm Max.

Order Information

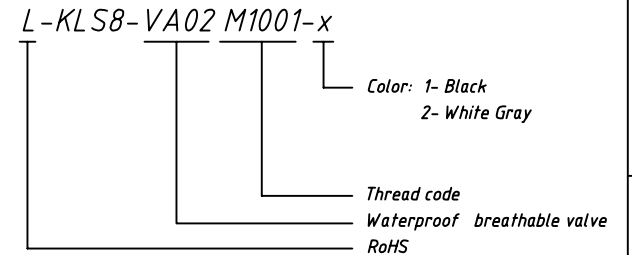

GENERAL TOLERANCE		ANGLE TOLERANCE		Description:	
X.	±0.60	X.	±5°	M10x1.5 waterproof breathable valve	
.X	±0.38	.X	±3°		
.XX	±0.25	.XX	±2°		
Draw	2018-01-20	PROJECTION		KLS P/N:	KLS8-VA02M1001-x
Check	2018-01-20	UNITS	mm		NingBo KLS ELECTRONIC CO.,L TD.
SCALE		SHEET SIZE	A4		

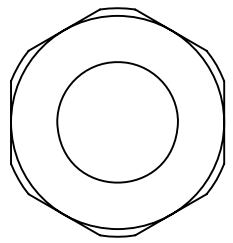

Nut

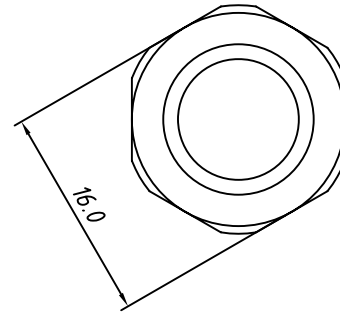
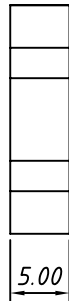

Material

Nut and Body Material: PC
Film: EPTFE
Sealing: NBR, EPDM
IP rating: IP67
Thread: M12×1.5
Panel Mounting: Ø12 or M12×1.5
Temp. Range: -40 °C ~ +110 °C
breathable valve Range: 3500ml/minute Max.
Maximum torque: 8Kgf.cm Max.

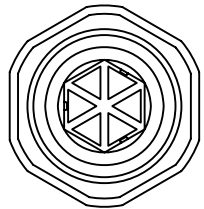

body

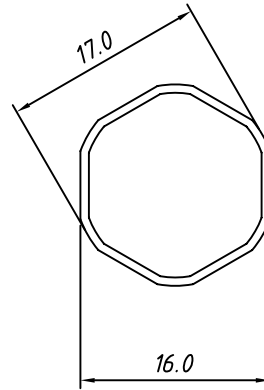
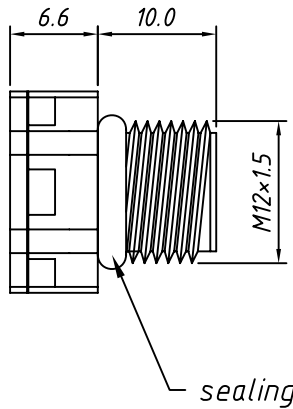

Order Information

L-KLS8-VA02 M1202-x 0

Nut: 0- With Nut
 1- Without Nut

Color: 1- Black
 2- White Gray

Thread code
 Waterproof breathable valve
 RoHS

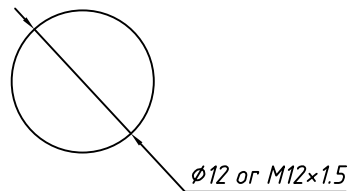

Panel Mounting
hole diameter

GENERAL TOLERANCE		ANGLE TOLERANCE		Description:	
X.	±0.60	X.	±5°	M12×1.5 waterproof breathable valve	
.X	±0.38	.X	±3°		
.XX	±0.25	.XX	±2°		
Draw		2018-01-20	PROJECTION	⊕	KLS P/N: KLS8-VA02M1202-x0
Check		2018-01-20	UNITS	mm	 NingBo KLS ELECTRONIC CO.,L TD.
SCALE			SHEET SIZE	A4	