

1  
RoHS Compliance

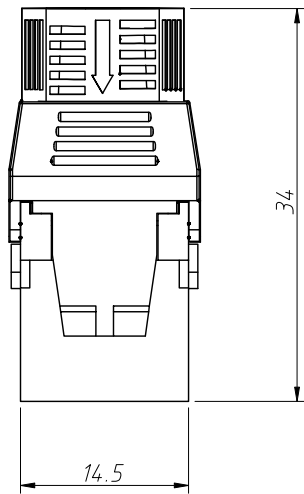
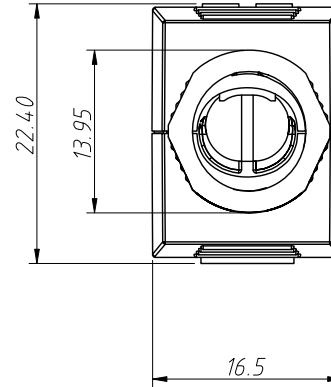
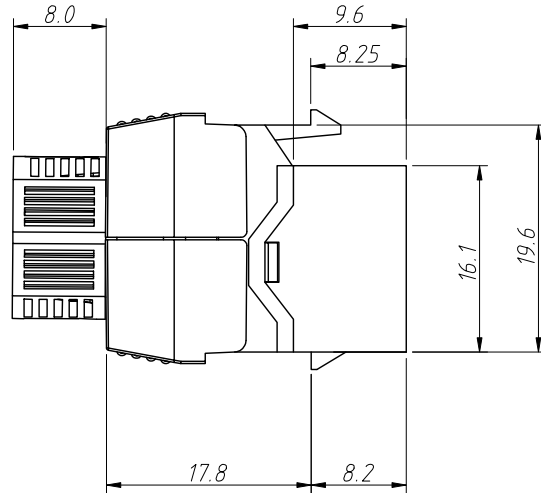
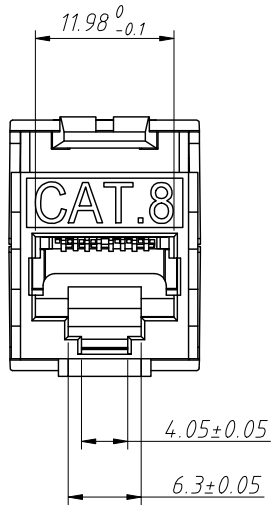

Notes:  
 1.Material  
 Insert:PC  
 Shell:Zinc Alloy  
 PCB:FR-4 T=1.6mm  
 Contact:Phosphor Bronze Stamp Pin  
 T=0.30mm  
 IDC Contact:Phosphor Bronze  
 T=0.50mm Tin Plating  
 RJ45 JACK Life:750 Times Min  
 IDC Life:200 Times Min  
 Wire:AWG 22~24

2.Electrical:  
 Voltage Rating:125 VAC RMS  
 Current Rating:1.5 AMP  
 Contact Resistance:100mΩ Max  
 Insulation Resistance:  
 1000 MΩ Min @ 500V DC  
 Dielectric Strength:  
 750V AC RMS 60Hz 1Min

3.Environmental:  
 Storage:-40°C ~ +85°C  
 Operation TEMP. :0°C ~ 70°C

ANGLE TOLERANCE	PROJECTION	Description:		
±3°		CAT8 FTP 8P8C Keystone Jacks		
GENERAL TOLERANCE	UNITS	mm	KLS P/N:	L-KLS12-DK8C001-8P8C
x.x ±0.30	SHEET SIZE	A4	XX	NingBo KLS ELECTRONIC CO.,L TD.
x.xx ±0.10	Draw:	Daniel	2023-06-26	
x.xxx ±0.05	Check:	Daniel	2023-06-26	