

1
RoHS Compliance

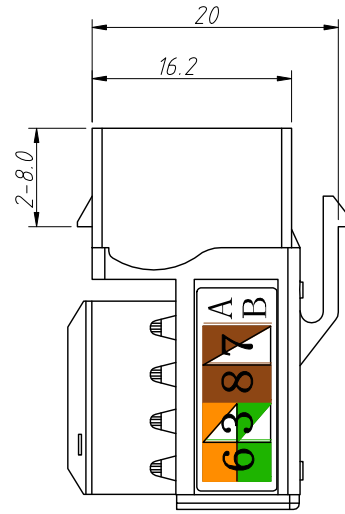
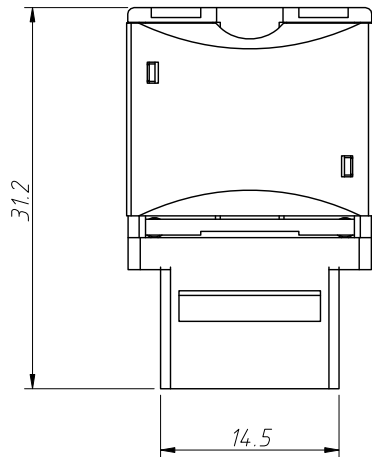
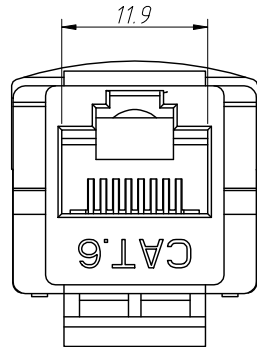
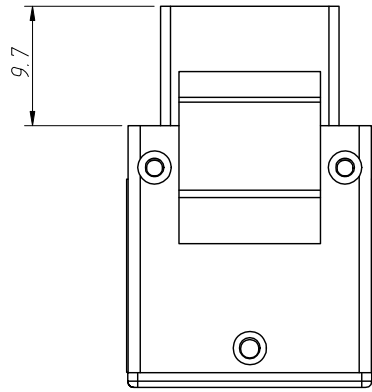

Notes:

1.Material:

Housing:PC,UL 94V-2

Contact:Phosphor Bronze,Gold Plated

2.Electric:

Suitable Wire Diameter:φ0.35~0.65mm

Contact Resistance:20mΩ Max

Insulation Resistance:500MΩ Min

Withstand Voltage Strength:

DC1000 V (AC700 V) For 1 Minute Without Breakdown Or Arcing Phenomenon

Electrical Transmission Performance:

In Accordance With ANSI/TIA 568C CAT6

ANGLE TOLERANCE	PROJECTION	Description:		
±3°		CAT5E UTP 8P8C Keystone Jacks		
GENERAL TOLERANCE		UNITS	mm	KLS P/N:
xx ±0.2	SHEET SIZE	A4	XX	L-KLS12-DK6C017-8P8C
x.x ±0.12	Draw:	Daniel	2023-06-26	NingBo KLS ELECTRONIC CO.,L TD.
x.xx ±0.08	Check:	Daniel	2023-06-26	