

1
RoHS Compliance

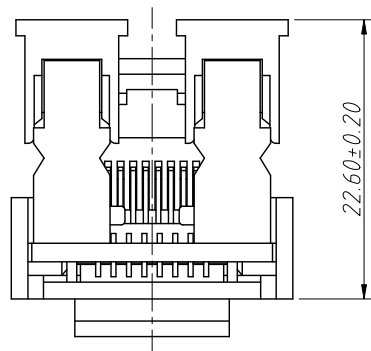

Section A-A

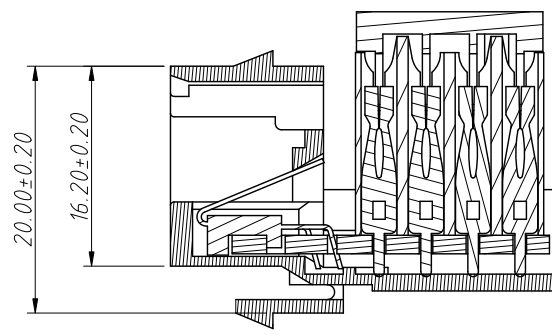
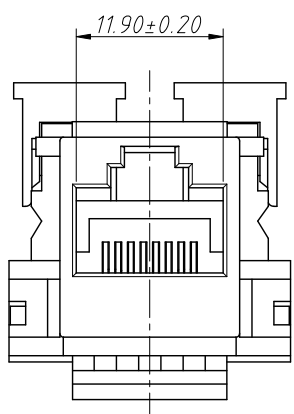
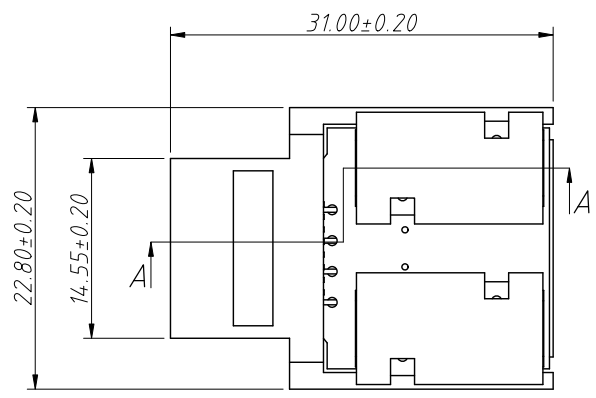
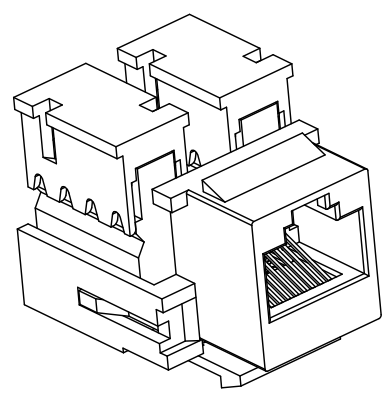
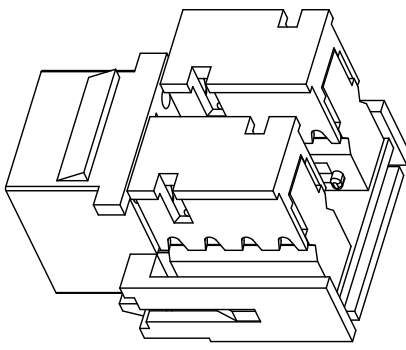

Notes:
 1.Material:
 Housing:PC,UL 94 V-2
 Contact:Phosphor Bronze,Gold Plated

 2.Electric:
 Contact Resistance:2.5mΩ Max
 Insulation Resistance:1000MΩ Min
 Withstand Voltage Strength:
 DC500 V (AC350 V) For 1 Minute Without
 Breakdown Or Arcing Phenomenon
 Electrical Transmission Performance:
 In Accordance With TIA/EIA 568 CAT5E

ANGLE TOLERANCE	PROJECTION	Description:		
±3°		CAT5E UTP 8P8C Keystone Jacks		
GENERAL TOLERANCE	UNITS	mm	KLS P/N:	L-KLS12-DK8001-8P8C
x.x ±0.20	SHEET SIZE	A4	XX	NingBo KLS ELECTRONIC CO.,L TD.
x.xx ±0.10	Draw:	Daniel	2023-06-12	
x.xxx ±0.05	Check:	Daniel	2023-06-12	