

1
RoHS Compliance

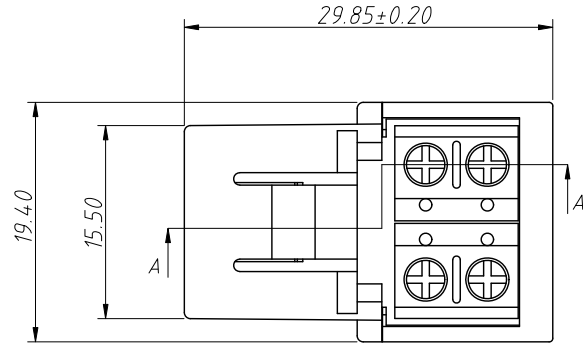

Notes:
1.Material:
Housing:PC,UL 94 V-2
Contact:Phosphor Bronze,Gold Plated

2.Electric:
Contact Resistance:2.5mΩ Max
Insulation Resistance:1000MΩ Min
Withstand Voltage Strength:
DC500 V (AC350 V) For 1 Minute Without
Breakdown Or Arcing Phenomenon
Electrical Transmission Performance:
In Accordance With TIA/EIA 568 CAT3

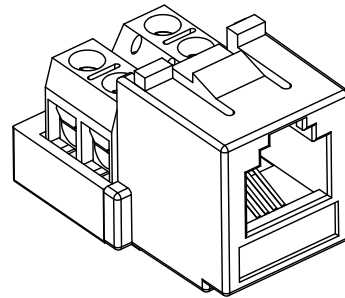
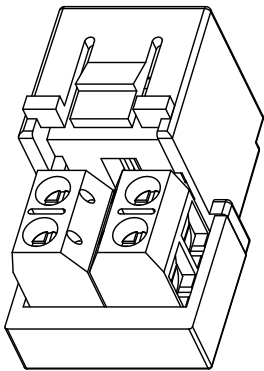
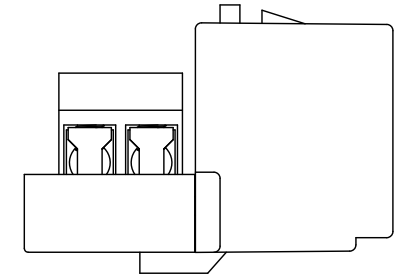
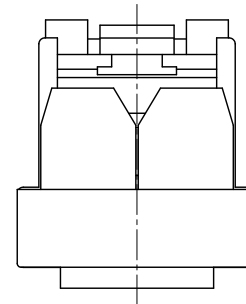
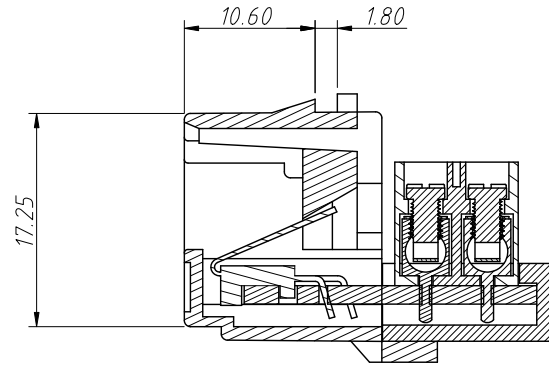
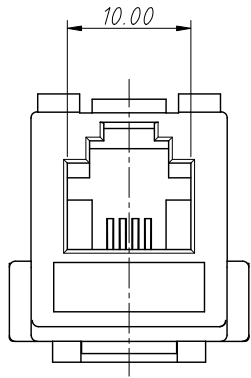

ANGLE TOLERANCE	PROJECTION		Description:	
±3°			CAT3 6P4C Keystone Jacks	
GENERAL TOLERANCE	UNITS	mm	KLS P/N:	L-KLS12-VK4401-6P4C
x.x ±0.20	SHEET SIZE	A4	XX	
x.xx ±0.10	Draw:	Daniel	2023-06-12	
x.xxx ±0.05	Check:	Daniel	2023-06-12	
			NingBo KLS ELECTRONIC CO.,L TD.	