

1  
RoHS Compliance

Optional Values	
L	4.15
L	4.45
L	4.65

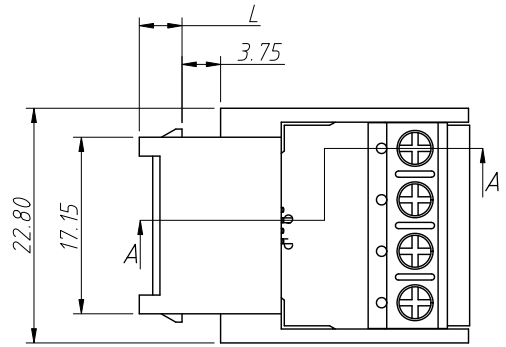

Notes:  
 1.Material:  
 Housing:PC,UL 94V-2  
 Contact:Phosphor Bronze,Gold Plated  
 2.Electric:  
 Contact Resistance:2.5mΩ Max  
 Insulation Resistance:1000MΩ Min  
 Withstand Voltage Strength:  
 DC500 V (AC350 V) For 1 Minute Without  
 Breakdown Or Arcing Phenomenon  
 Electrical Transmission Performance:  
 In Accordance With TIA/EIA 568 CAT3

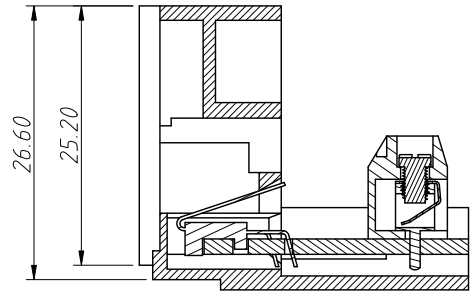
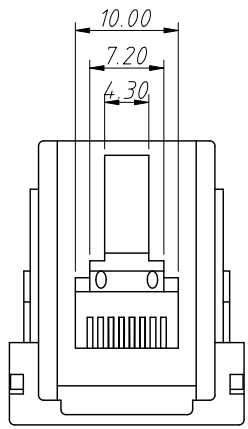

Section A-A

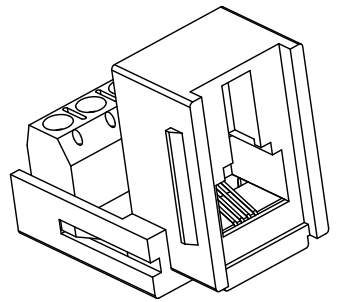
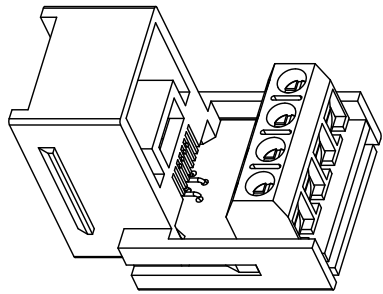
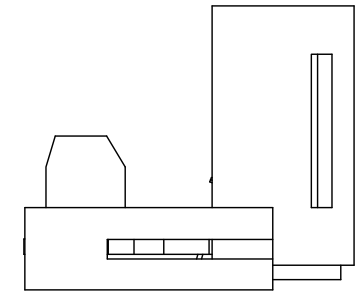
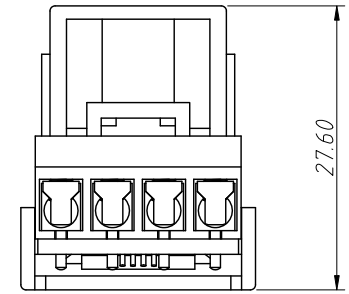

ANGLE TOLERANCE	PROJECTION	Description:	
±3°		CAT3 8P4C Keystone Jacks	
GENERAL TOLERANCE	UNITS	mm	KLS P/N:
x.x ±0.20	SHEET SIZE	A4	XX
x.xx ±0.10	Draw:	Daniel	2023-06-12
x.xxx ±0.05	Check:	Daniel	2023-06-12

NingBo KLS ELECTRONIC CO.,L TD.