

1
RoHS Compliance

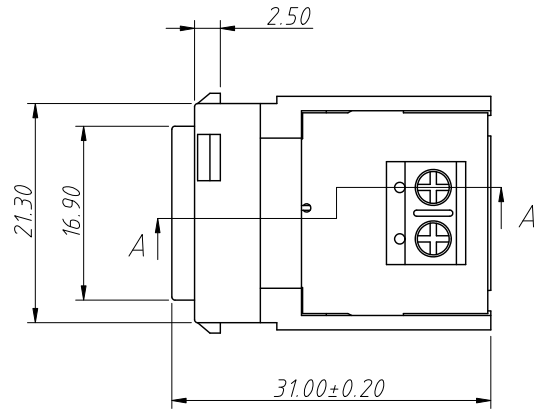

Notes:

1.Material:

Housing:PC,UL94V-2

Contact:Phosphor Bronze,Gold Plated

2.Electric:

Suitable Wire Diameter: $\phi 0.35 \sim 0.65\text{mm}$

Contact Resistance: $2.5\text{m}\Omega$ Max

Insulation Resistance: $1000\text{M}\Omega$ Min

Withstand Voltage Strength:

DC500 V (AC350 V) For 1 Minute Without
Breakdown Or Arcing Phenomenon

Electrical Transmission Performance:

In Accordance With TIA/EIA 568 CAT3

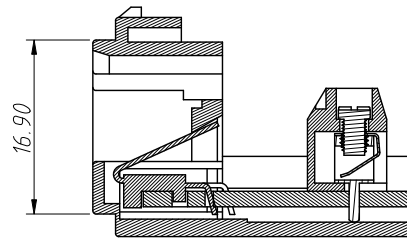
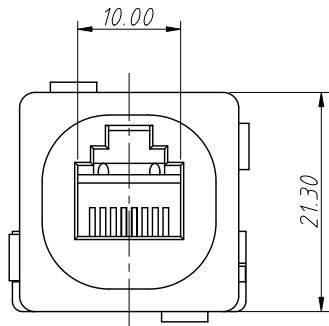

Section A-A

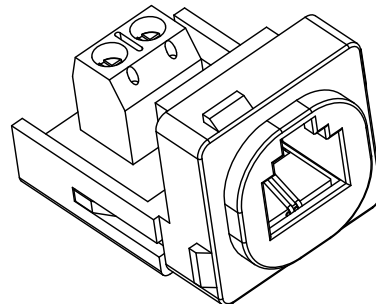
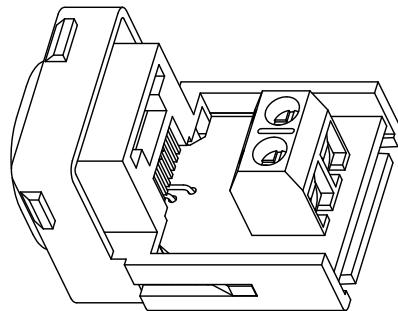
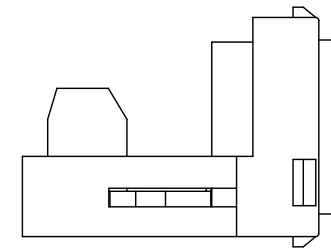
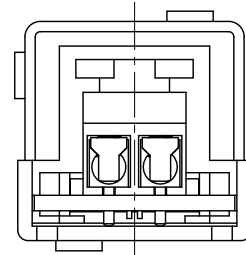

ANGLE TOLERANCE	PROJECTION	Description:		
$\pm 3^\circ$		CAT3 8P2C Keystone Jacks		
GENERAL TOLERANCE	UNITS	mm	KLS P/N:	L-KLS12-VK2101-8P2C
x.x ± 0.20	SHEET SIZE	A4	XX	NingBo KLS ELECTRONIC CO.,L TD.
x.xx ± 0.10	Draw:	Daniel	2023-06-12	
x.xxx ± 0.05	Check:	Daniel	2023-06-12	