

1
RoHS Compliance

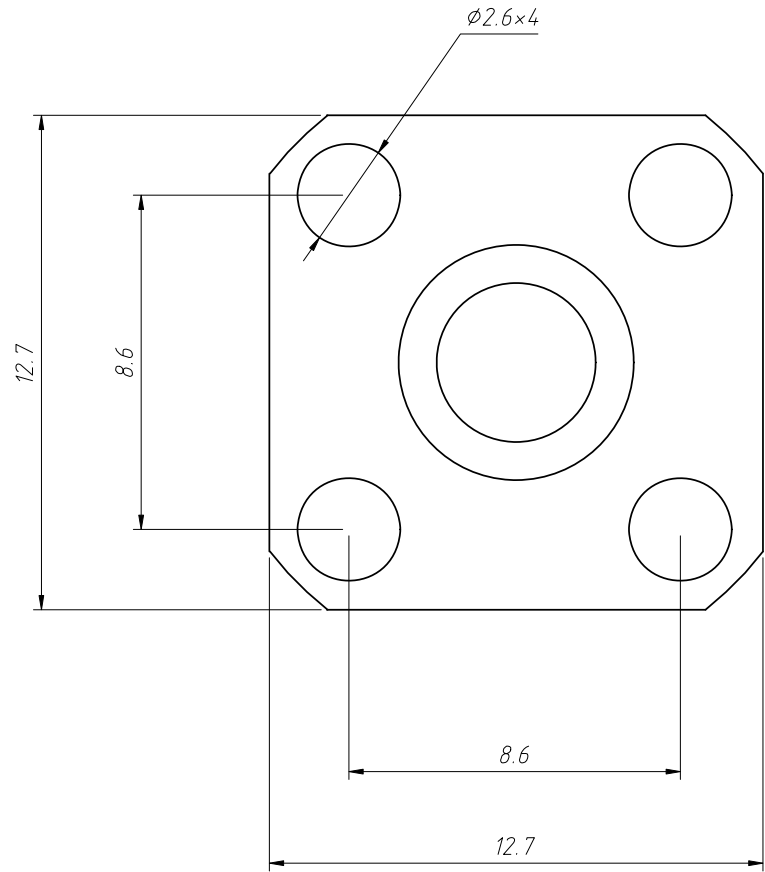
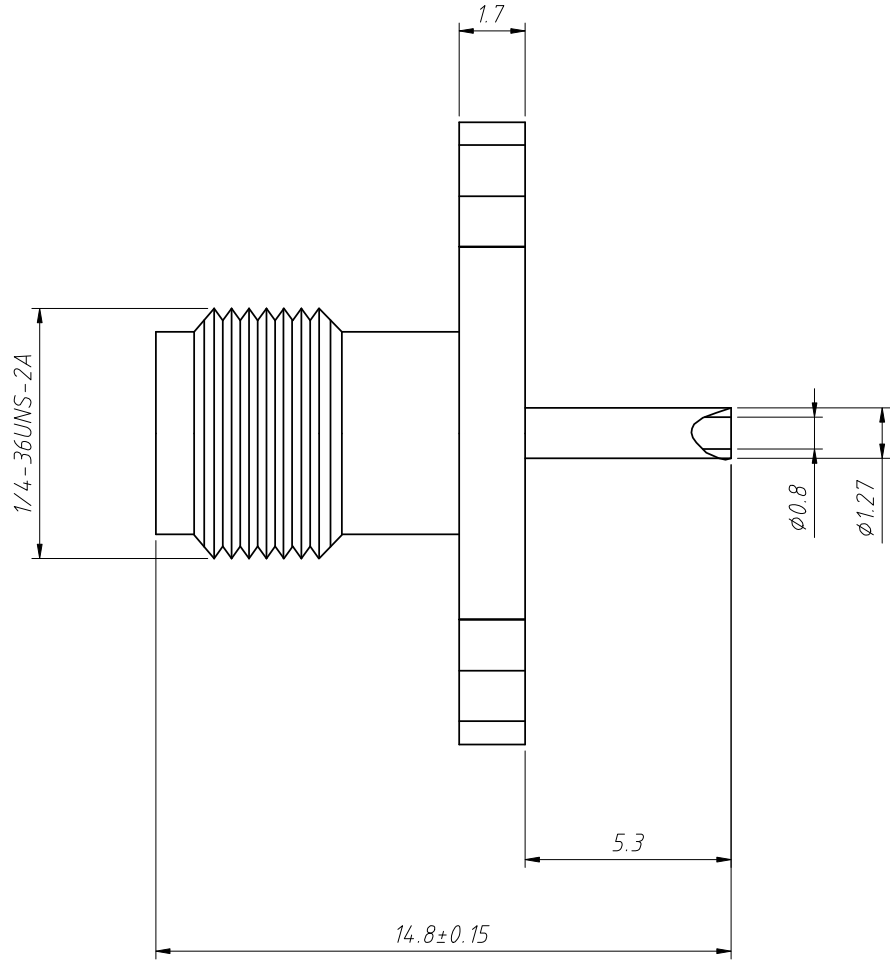

Specifications:
 Impedance:50Ω
 Frequency Range:0-6 GHz
 Material: Brass
 Surface:Gold Plating
 Durability:500Cycles Min

ANGLE TOLERANCE	PROJECTION	Description:	Flange Panel Mount SMA Connector With Jack Female Straight Type	
±3°				
GENERAL TOLERANCE	UNITS	mm	KLS P/N:	L-KLS1-SMA024
x.x ±0.30	SHEET SIZE	A4		
x.xx ±0.20	Draw:	Daniel	2018-07-10	NingBo KLS ELECTRONIC CO.,LTD.
x.xxx ±0.10	Check:	Daniel	2018-07-10	