

SMA Connector Series

KLS1-SMA016 SMA Connector Series

Electrical Specifications

Impedance: 50 Ω Frequency Range: 0-6GHz
Voltage Rating : 335 volts rms.
Dielectric Withstanding Voltage : 500 volts rms. VSWR :

1.15 +0 .02 f (GHz) for Straight connector typical
1.25 +0 .025 f (GHz) for Right angle connector typical
Contact Resistance: Center contact: 2.0 mΩ
Body: 2.0 mΩ
Insulation Resistance: 5,000 MΩ

Mechanical Specifications

Mating: 1/4"-36 UNS thread coupling
Cable retention: 6kgf typical
Durability: 500Cycles Min.
Coupling nut retention: 18kgf Min.
Temperature Range: - 55°C to +155°C

Material

Connector body: Brass per QQ-B-626 ,gold Plating or nickel
Center contact Male: Brass, gold Plating
Center contact Female: Beryllium copper, gold Plating
Insulator: PTFE
Gasket: Silicone rubber
Crimp Ferrule: Annealed copper

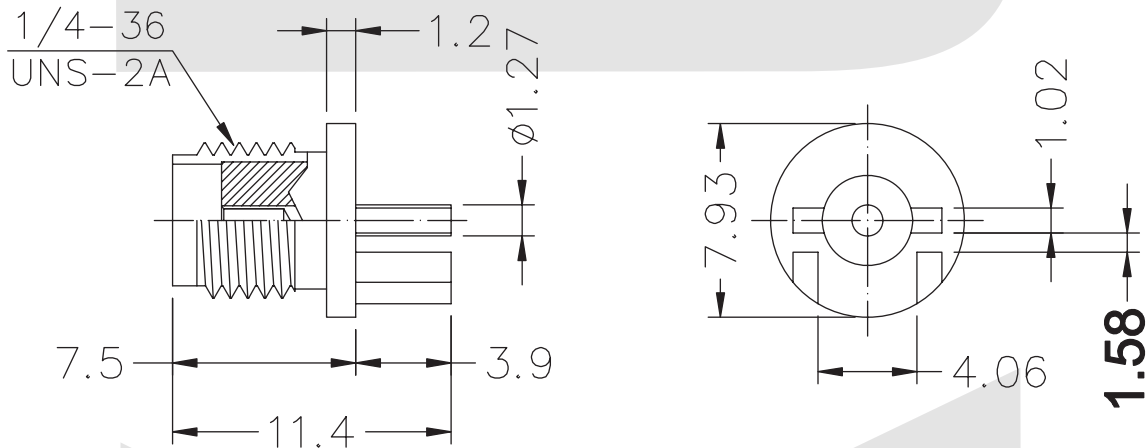

ORDER INFORMATION

Product NO.: KLS1-SMA016

Pos. NO. _____
SMA Connector Type _____