



SMA Connector Series

KLS1-SMA006 PCB Mount SMA Connector (Jack, Male, 50Ω)

Electrical Specifications:

Impedance: 50 Ω
 Frequency Range: 0-6 GHz
 Flexible cables: 0-12.4 GHz
 Voltage Rating : 335 volts rms.
 Dielectric Withstanding Voltage : 500 volts rms.
 VSWR : 1.15 +0 .02 f (GHz) for Straight connector typical
 1.25 +0 .025 f (GHz) for Right angle connector typical
 Contact Resistance Center contact: 2.0 mΩ
 Body: 2.0 mΩ
 Insulation Resistance: 5,000 MΩ

Mechanical Specifications:

Mating: 1/4"-36 UNS thread coupling
 Cable retention: 6kgf typical
 Durability: 500 Cycles Min.
 Coupling nut retention: 18kgf Min.
 Temperature Range: - 55°C to +155°C

Material:

Connector body: Brass per QQ-B-626 ,gold Plating or nickel
 Center contact Male: Brass, gold Plating
 Center contact Female: Beryllium copper, gold Plating
 Insulator: PTFE
 Gasket: Silicone rubber
 Crimp Ferrule: Annealed copper

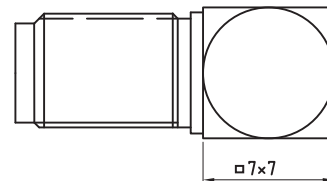
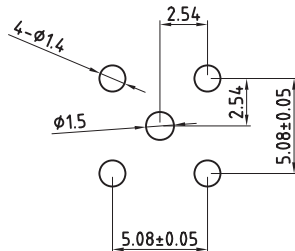
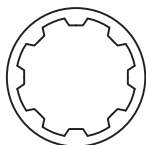
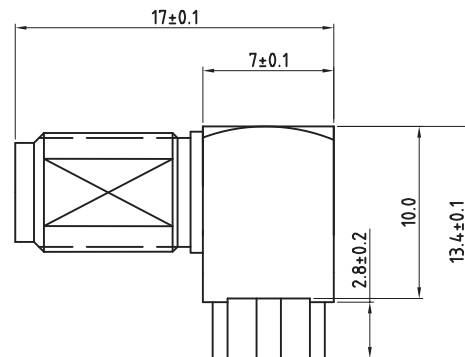
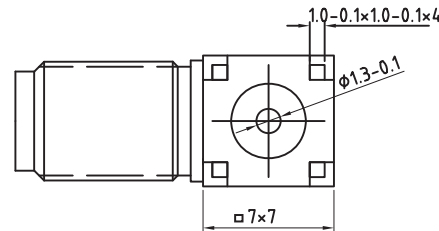
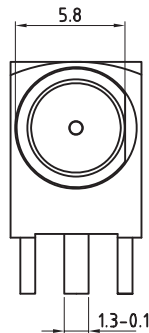
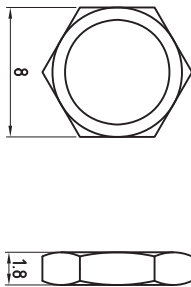
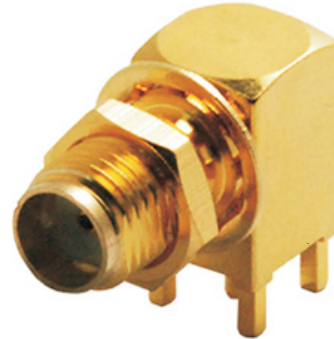

ORDER INFORMATION

Product NO.: KLS1-SMA006

