

RoHS Compliance

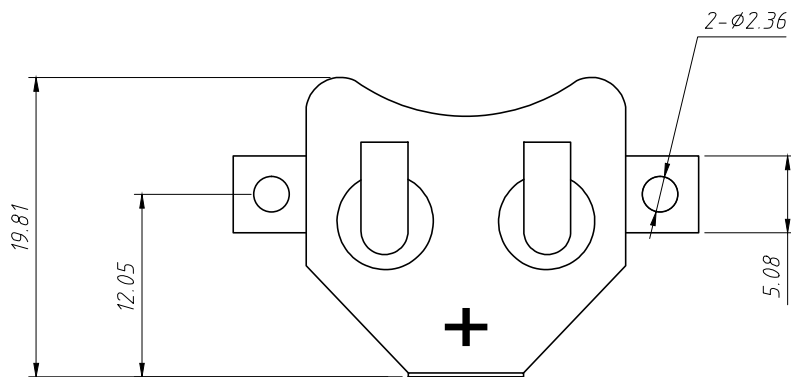

Notes:

1:Material:

Phosphor Bronze T=0.25mm, Nickel Plated.

2:Electric:

Dielectric Voltage:500V AC One Sec Level.

Contact Resistance:30 mΩ Max.

Insulator Resistance:100 MΩ Min.

Operating Temperature:-40°C ~ +85°C.

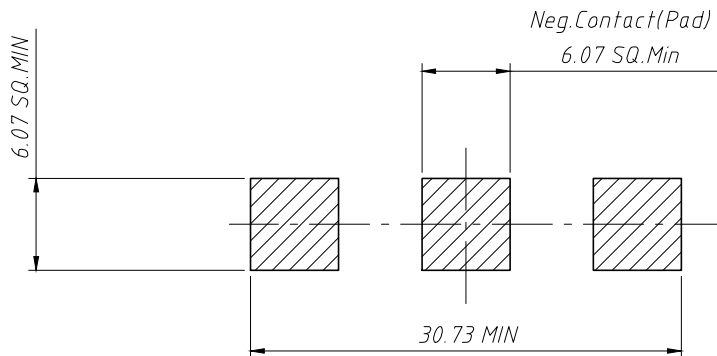
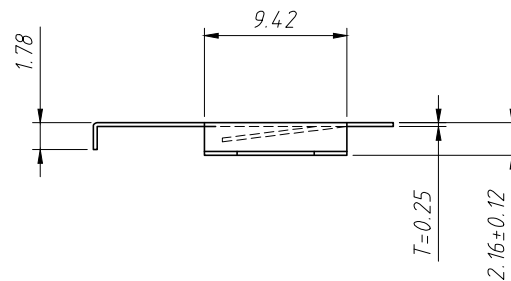
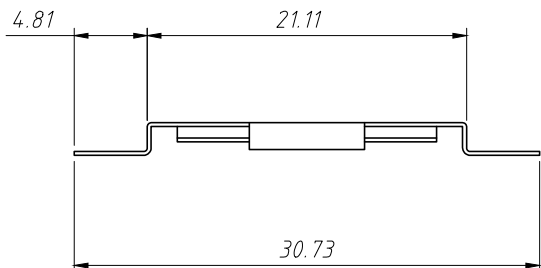

Recommended PCB Layout
Tolerance:±0.05mm

ANGLE TOLERANCE	PROJECTION	Description:
±3°		CR2016 Coin Cell Retainers
GENERAL TOLERANCE	UNITS	mm
x.x ±0.30	SHEET SIZE	A4
x.xx ±0.20	Draw:	Daniel 2023-02-21
x.xxx ±0.10	Check:	Daniel 2023-02-21

CR2016 Coin Cell Retainers

L-KLS5-CR2016-11



NingBo KLS ELECTRONIC CO.,LTD.