

RoHS Compliance

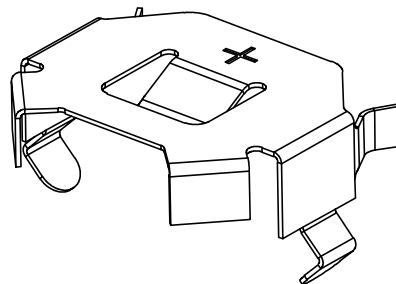
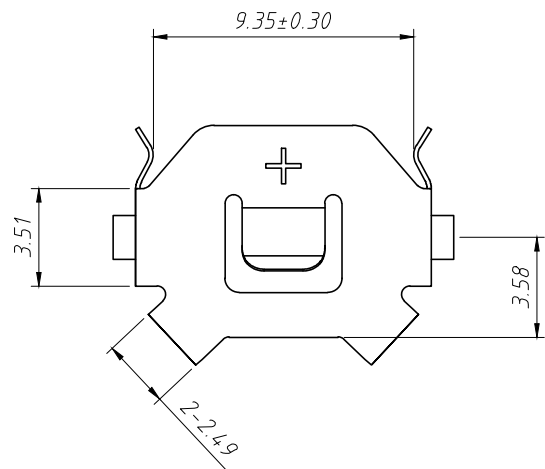

Notes:

1:Material:

Phosphor Bronze T=0.15mm, Nickel Plated.

2:Electric:

Dielectric Voltage:500V AC One Sec Level.

Contact Resistance:30 mΩ Max.

Insulator Resistance:100 MΩ Min.

Operating Temperature:-40°C ~ +85°C.

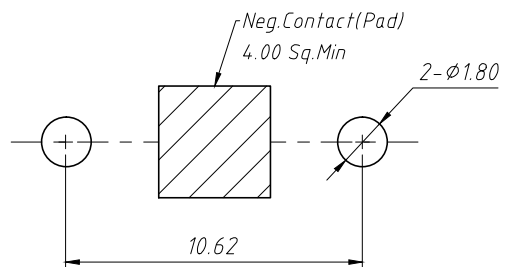
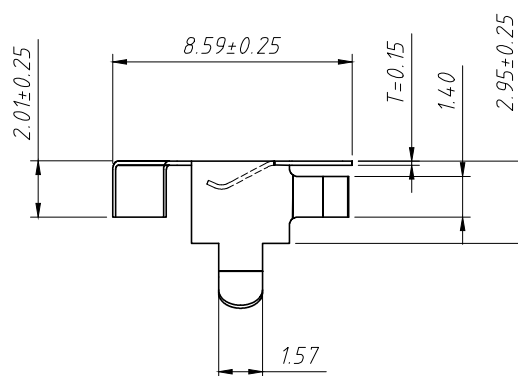
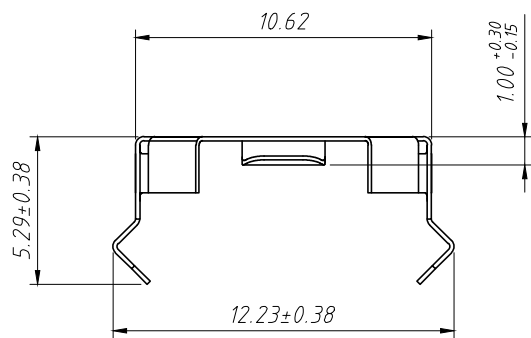

Recommended PCB Layout
Tolerance:±0.05mm

ANGLE TOLERANCE		PROJECTION		Description:	
±3°				CR1025 Coin Cell Retainers	
GENERAL TOLERANCE		UNITS	mm	KLS P/N:	L-KLS5-CR1025-02
x.x	±0.30	SHEET SIZE	A4	Draw:	Daniel 2023-02-14
x.xx	±0.20	Check:	Daniel	2023-02-14	NingBo KLS ELECTRONIC CO.,LTD.
x.xxx	±0.10				