

1
RoHS Compliance

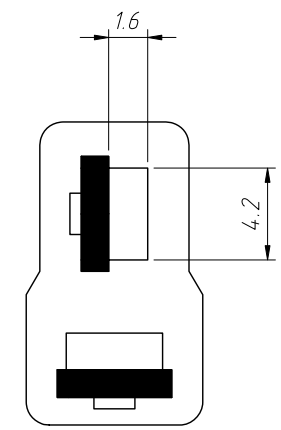
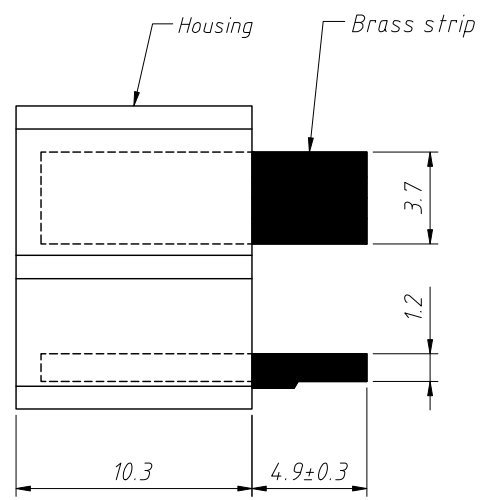
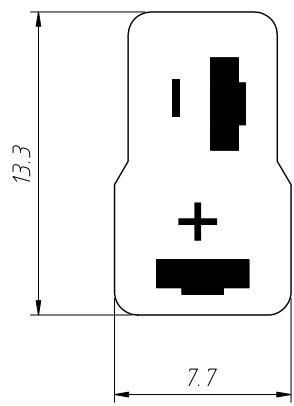

Material:
Housing: PA66 UL94-V2, Red Color
Brass strip: Gold-plated

Instructions:
Allowable carrying current: 20 A
Operating temperature: -30°C ~ 120°C
Weight: 1.95g
With "L-KLS1-XT01-M-6" Supporting the use
Product in a single welding line processing shall not exceed 10 seconds,
otherwise there will be high temperature oxidation welding.

Order Information:
L-KLS1-XT01-F-6
└─ L: RoHS
└─ Product series
└─ Type: F-Female
└─ Color: 6-Red

ANGLE TOLERANCE	PROJECTION	Description:	
±3°		T Type Female plug Red	
GENERAL TOLERANCE	UNITS	mm	KLS P/N:
x.x ±0.30	SHEET SIZE	A4	L-KLS1-XT01-F-6
x.xx ±0.20	Draw:	Daniel	2022-08-25
x.xxx ±0.10	Check:	Daniel	2022-08-25

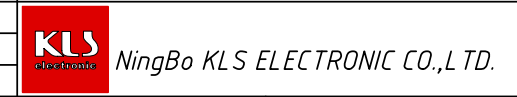

1
RoHS Compliance

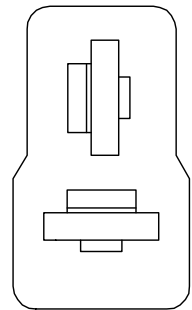
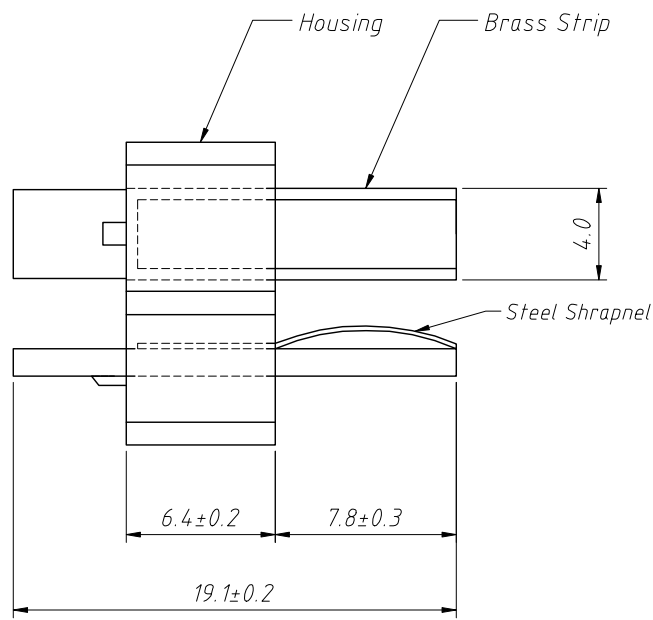
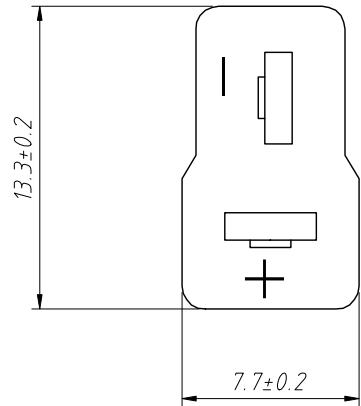

Material:
 Housing: PA66, UL 94-V2, Red Color
 Brass Strip: Gold-plated
 Steel Shrapnel: Nickel plating

Instructions:
 Allowable carrying current: 20 A
 Operating temperature: -30°C ~ 120°C
 Weight: 2.1g
 With "L-KLS1-XT01-F-6" Supporting the use
 Product in a single welding line processing shall not exceed 10 seconds,
 otherwise there will be high temperature oxidation welding.

Order Information:
 L-KLS1-XT01-M-6
 L: RoHS
 Product series
 Type: M-Male
 Color: 6-Red

ANGLE TOLERANCE	PROJECTION	Description:	
±3°		T Type Male plug Red	
GENERAL TOLERANCE	UNITS	mm	KLS P/N:
x.x ±0.30	SHEET SIZE	A4	L-KLS1-XT01-M-6
x.xx ±0.20	Draw:	Daniel	2022-08-25
x.xxx ±0.10	Check:	Daniel	2022-08-25

