

1  
RoHS Compliance

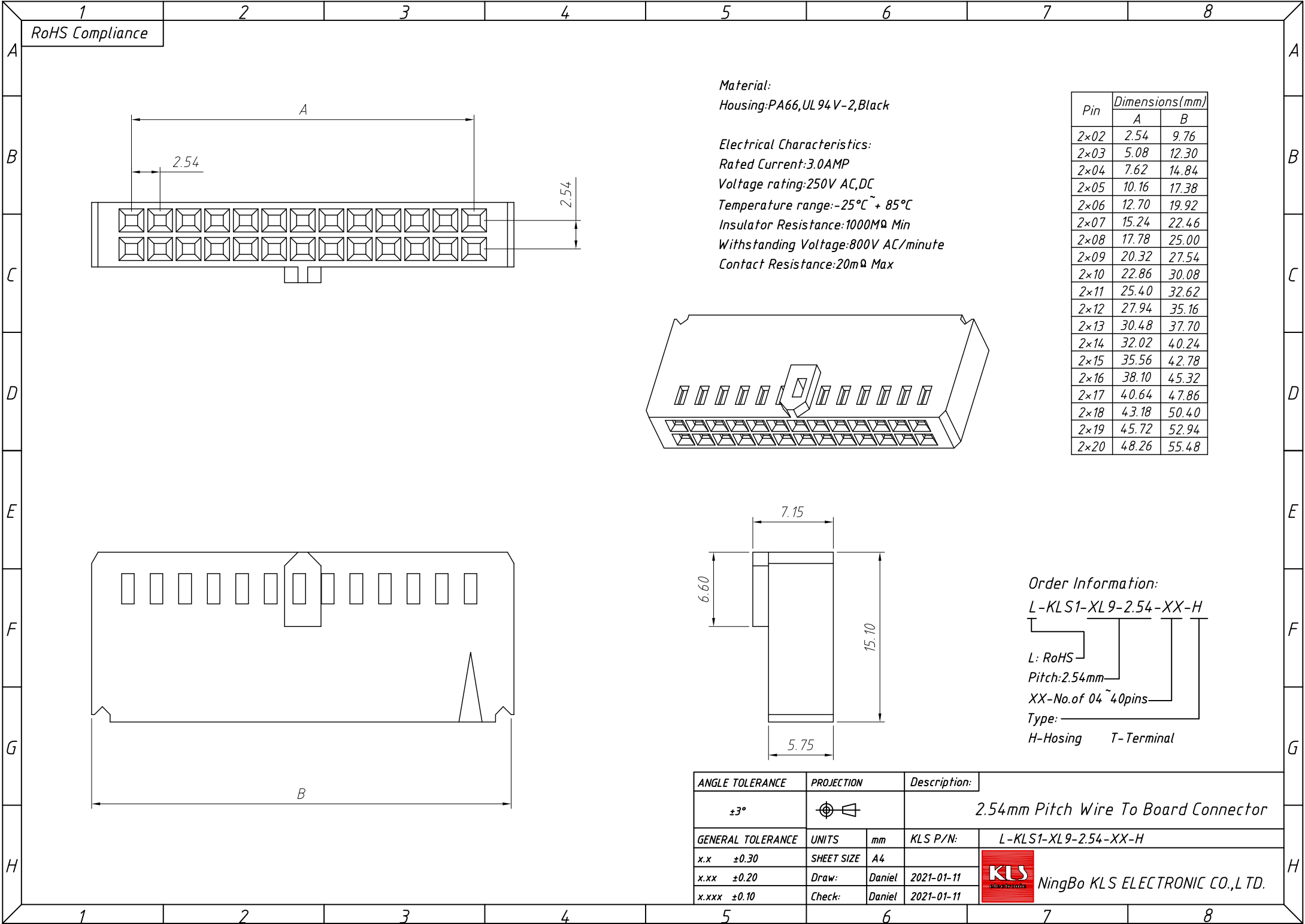

Material:  
Housing:PA66,UL 94 V-2,Black

Electrical Characteristics:  
Rated Current:3.0AMP  
Voltage rating:250V AC,DC  
Temperature range:-25°C ~ + 85°C  
Insulator Resistance:1000MΩ Min  
Withstanding Voltage:800V AC/minute  
Contact Resistance:20mΩ Max

Pin	Dimensions(mm)	
	A	B
2×02	2.54	9.76
2×03	5.08	12.30
2×04	7.62	14.84
2×05	10.16	17.38
2×06	12.70	19.92
2×07	15.24	22.46
2×08	17.78	25.00
2×09	20.32	27.54
2×10	22.86	30.08
2×11	25.40	32.62
2×12	27.94	35.16
2×13	30.48	37.70
2×14	32.02	40.24
2×15	35.56	42.78
2×16	38.10	45.32
2×17	40.64	47.86
2×18	43.18	50.40
2×19	45.72	52.94
2×20	48.26	55.48

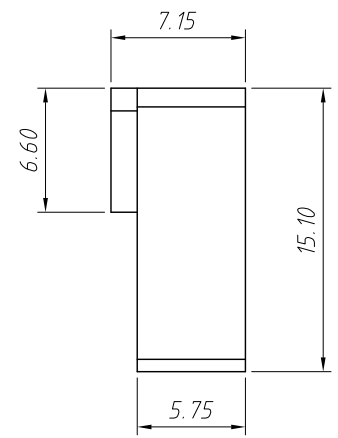
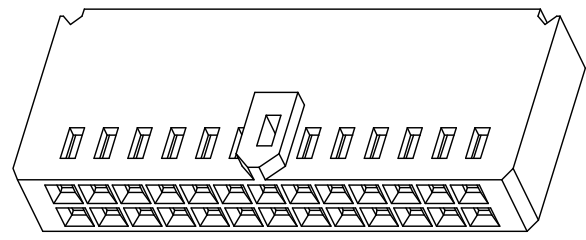

Order Information:  
L-KLS1-XL9-2.54-XX-H  
L: RoHS  
Pitch:2.54mm  
XX-No.of 04 ~ 40pins  
Type:  
H-Hosing T-Terminal

ANGLE TOLERANCE	PROJECTION		Description:	
±3°			2.54mm Pitch Wire To Board Connector	
GENERAL TOLERANCE	UNITS	mm	KLS P/N:	L-KLS1-XL9-2.54-XX-H
x.x ±0.30	SHEET SIZE	A4		
x.xx ±0.20	Draw:	Daniel	2021-01-11	
x.xxx ±0.10	Check:	Daniel	2021-01-11	

**NingBo KLS ELECTRONIC CO.,L TD.**

1  
RoHS Compliance

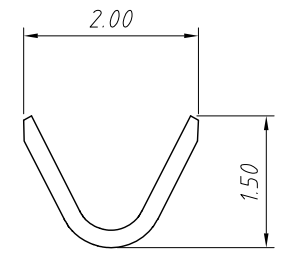
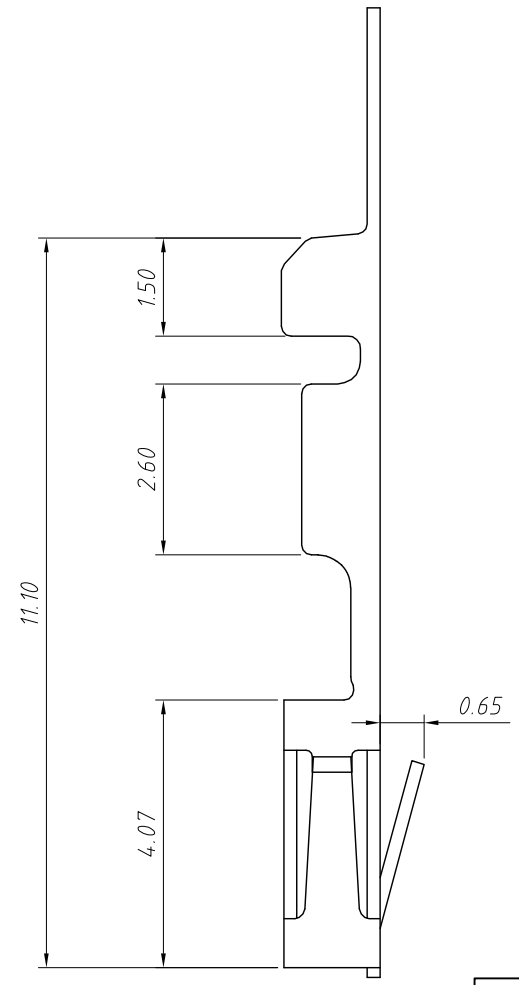
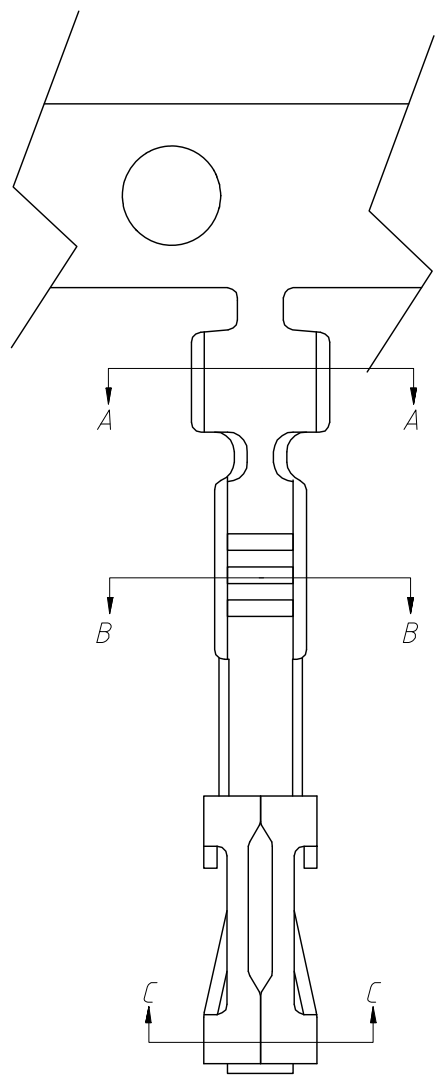

A-A

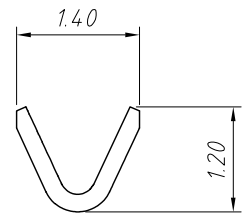

B-B

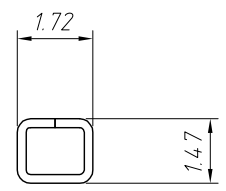

C-C

**Material:**  
 Terminal: Phosphor Bronze  
 Plating: Tin plated  
 Applicable wires: AWG #28 ~ # 24  
 Insulation O.D: 1.60mm  
 Qty/reel: 10000 pcs

**Electrical Characteristics:**  
 Rated Current: 3.0AMP  
 Voltage rating: 250V AC,DC  
 Temperature range: -25°C ~ + 85°C  
 Insulator Resistance: 1000MΩ Min  
 Withstanding Voltage: 800V AC/minute  
 Contact Resistance: 20mΩ Max

**Order Information:**  
 L-KLS1-XL9-2.54-T

L: RoHS  
 Pitch: 2.54mm  
 Type: H-Hosing T-Terminal

ANGLE TOLERANCE	PROJECTION	Description:		
±3°		2.54mm Pitch Wire To Board Connector		
GENERAL TOLERANCE	UNITS	mm	KLS P/N:	L-KLS1-XL9-2.54-T
x.x ±0.30	SHEET SIZE	A4		
x.xx ±0.20	Draw:	Daniel	2021-01-11	
x.xxx ±0.10	Check:	Daniel	2021-01-11	

**NingBo KLS ELECTRONIC CO.,LTD.**