

Proper Cable

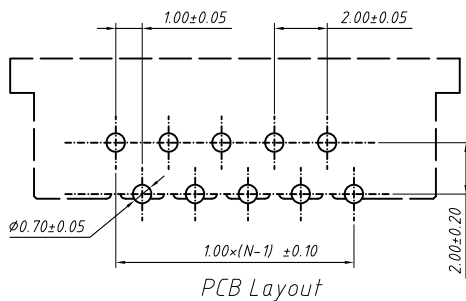

Material
 Housing: LCP UL94V-0
 Lock: PA46, UL94V-0
 Plug spring: Phosphor Bronze, Gold/Tin

Electrical
 Voltage rating: 50 V
 Current Rating: 0.5 A
 Withstanding Voltage: 500 V
 Insulation resistance: 800MΩ.Min.
 Contact resistance: 20 mΩ.Max.

Mechanical
 Temp. Range: -25 °C ~ +85 °C

Order Information

L-KLS1-1240E-2.5-XX-R-A-T

RoHS
 Series No.

No. of pins (02~35 pins)
 R-Right angle Pin
 A-Anti-needle
 Pack: T-Tube

GENERAL TOLERANCE		ANGLE TOLERANCE		PROJECTION	Description:	
X	±0.15	X	±5°	UNITS	CONN FFC 1.00mm, Anti-needle, THR, 90°, with ZIF	
.X	±0.03	.X	±3°	SHEET SIZE		A4
.XX	±0.05	.XX	±2°	KLS P/N:		L-KLS1-1240E-2.5-XX-R-A-T

Draw by: Date	2018-03-10
Check by: Date	2018-03-10
SCALE	SHEET OF



NingBo KLS ELECTRONIC CO.,LTD.

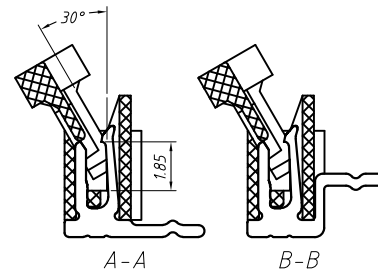
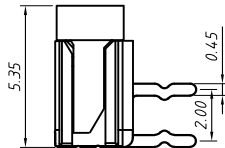
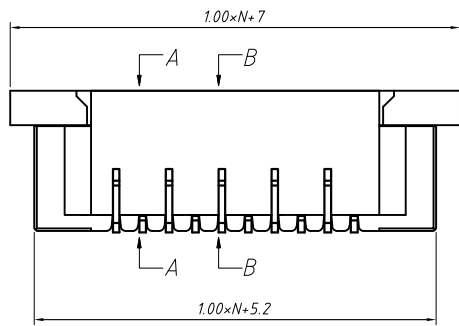

Material
 Housing: LCP UL94V-0
 Lock: PA46, UL94V-0
 Plug spring: Phosphor Bronze, Gold/Tin

Electrical
 Voltage rating: 50 V
 Current Rating: 0.5 A
 Withstanding Voltage: 500 V
 Insulation resistance: 800M Ω .Min.
 Contact resistance: 20 m Ω .Max.

Mechanical
 Temp. Range: -25 °C ~ +85 °C

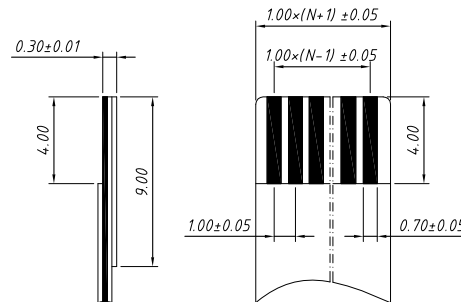
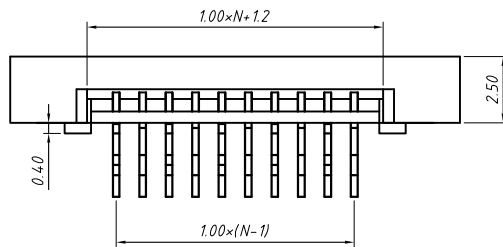

Proper Cable

Order Information

L-KLS1- 1240E -2.5- XX -R-P-T

RoHS
 Series No.

No. of pins (02 ~ 35 pins)
 R-Right angle Pin
 P-Positive needle
 Pack: T-Tube

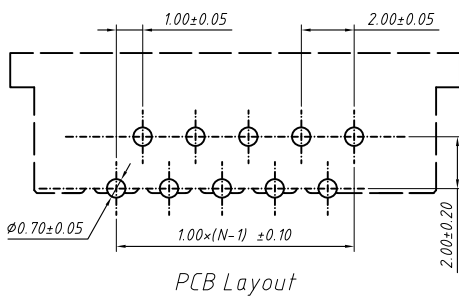

GENERAL TOLERANCE		ANGLE TOLERANCE		PROJECTION	Description:
X.	±0.15	X.	±5°	UNITS	CONN FFC 1.00mm, Positive needle, THR, 90°, with ZIF L-KLS1-1240E-2.5-XX-R-P-T
.X	±0.03	.X	±3°	SHEET SIZE	
.XX	±0.05	.XX	±2°	KLS P/N:	

Draw by: Date	2018-03-10
Check by: Date	2018-03-10
SCALE	SHEET OF



NingBo KLS ELECTRONIC CO.,LTD.