

1  
RoHS Compliance

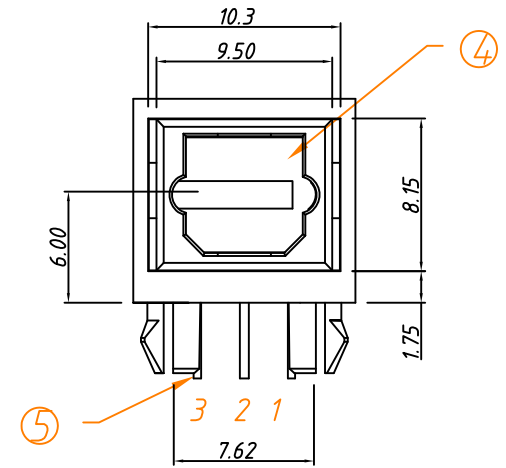

Pin Function  
 1- GND  
 2- Vcc  
 3- Vin

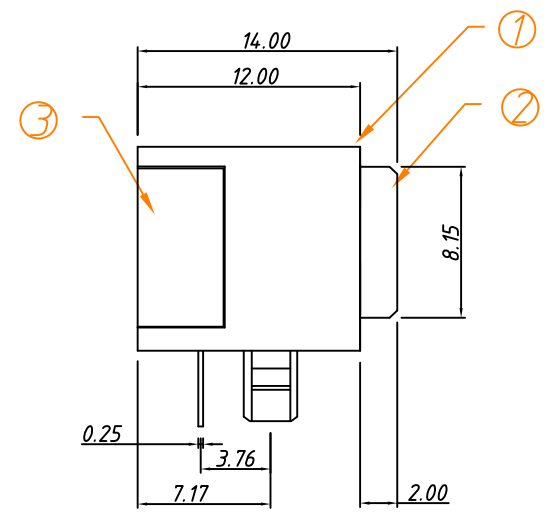
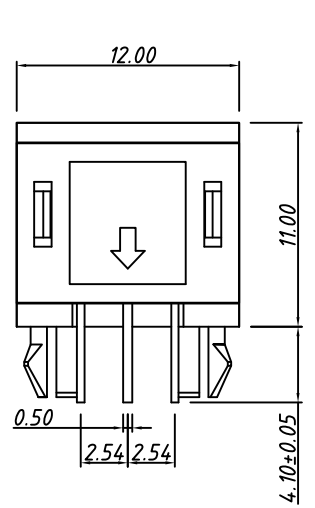
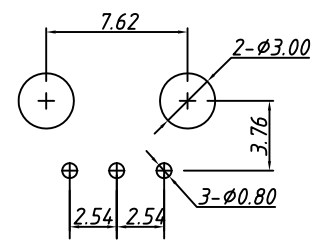

P.C.B LAYOUT  
 TOLERANCE:±0.30

Order information:  
 L-KLS1-SJ T -012-XXX  
 L: RoHS  
 T: Transmitter  
 XXX: Frequency  
 96K- 96KHz  
 192K- 192KHz

5	IR		1	Transmitter
4	Shutter	PBT	1	
3	COVER	PBT	1	
2	SET	PBT	1	
1	Body	PBT	1	
ITEM	PART NAME	Material	Q'TY	REMARK

PROJECTION		Description:
UNITS	mm	Transmitters FIBER OPTIC Jacks
SCALE	1:1	
Draw:	Daniel	KLS P/N: L-KLS1-SJT-012-XXX
Check :	Daniel	 NingBo KLS ELECTRONIC CO.,L TD.
Date	2020-03-02	
TOLERANCE	±0.20	