

RoHS Compliant

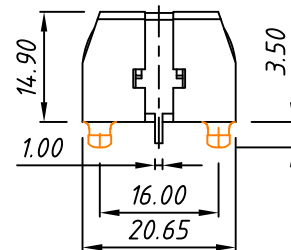

With Post

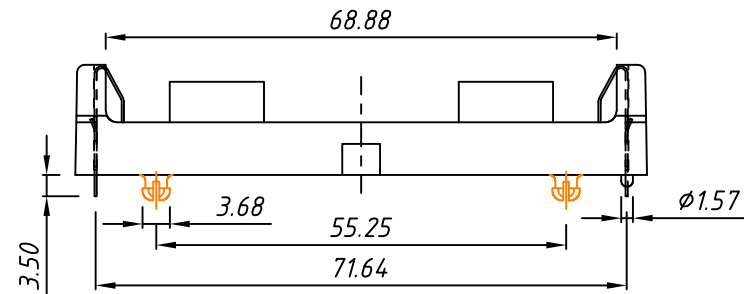
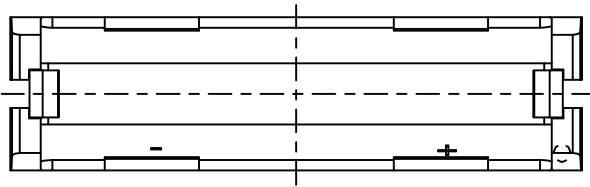
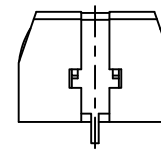

Without Post

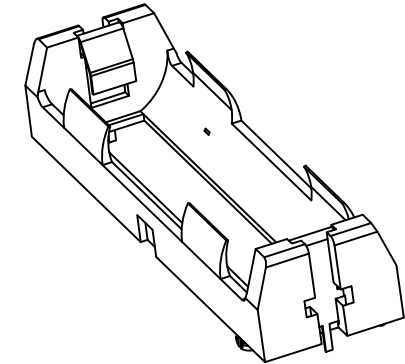

MATERIAL

Insulator: Nylon 66,Black,UL94V-0
 Contact: 0.35 Phosphor Bronze,
 Nickel plated

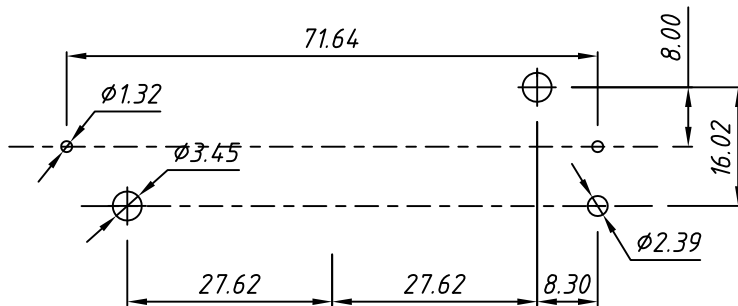
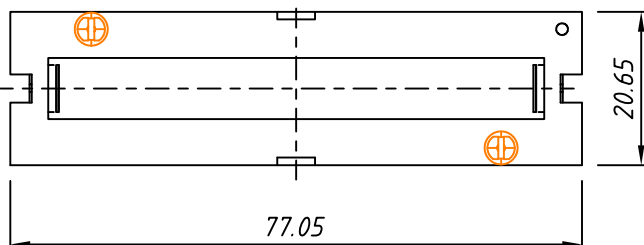

RECOMMENDED PCB LAYOUT
 TOLERANCE: ± 0.05

ORDER INFORMATION:

L - KLS5 - 18650 - 010 - D X

RoHS

1 Li-ion 18650 Battery Holder

D: with PC Pin

Post: 0- without Post

1- with Post

GENERAL TOLERANCE	± 0.50	PROJECTION	Description:	1 Li-ion 18650 Battery Holder, with PC Pin
		UNITS		
Angle TOLERANCE	$\pm 3^\circ$	SHEET SIZE	A4	
		KLS P/N:	L-KLS5-18650-010-D X	
Draw:	Daniel	 NingBo KLS ELECTRONIC CO.,L TD.		
Check:	Daniel			
Data:	2019-03-08			