

SECTION A-A

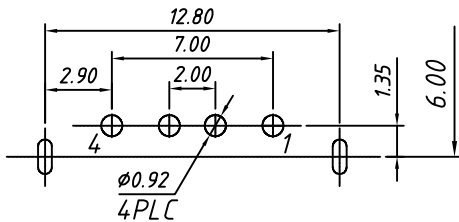
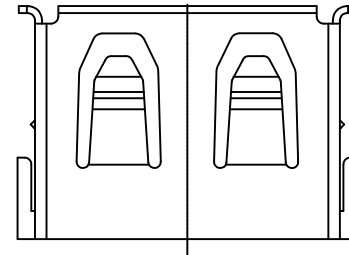
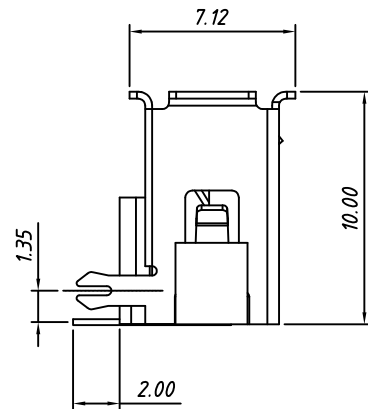
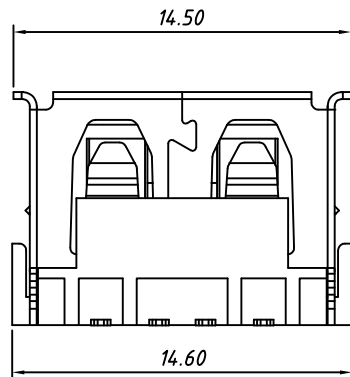
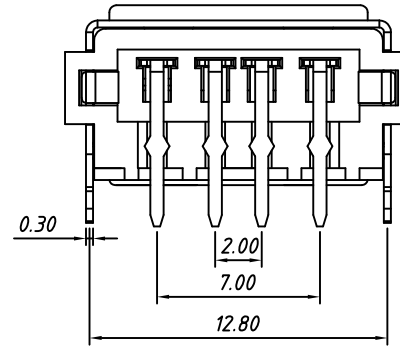

RECOMMENDED PCB LAYOUT  
TOLERANCE: ±0.05

**Material**  
 Housing:Hing Temperature Thermoplastic,  
 UL 94 V-0 PBT,Black/White.  
 Contact:Copper Alloy C2680.  
 Shell:Copper Alloy C2680/SPCC.

**Finish:**  
 Contact:Plated Gold In Mating Area;  
 Tin On Solder Tails.  
 Shell:Nickel Plating.

**Electrical:**  
 Current Rating:1.5A/Contact Terminal.  
 Voltage Rating:30V DC  
 Contact Resistance:30mΩ Max.  
 Dielectric Withstanding Voltage:  
 500 V AC AT Sea Level.  
 Insulation Resistance:1000MΩ Min.  
 Connector Mate and Unmated Force  
 Mate Force:3.75kgf Max.  
 Unmated Force:1.02kgf Min.  
 Terminal Retention:1.2kgf Min.

**Order Information**

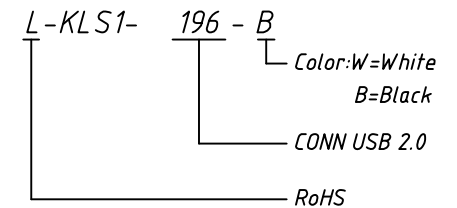

GENERAL TOLERANCE		ANGLE TOLERANCE		PROJECTION		Description:	
X.	±0.60	X.	±5°	UNITS	mm	CONN COM TYPE A USB Female R/A,L 10.0 L-KLS1-196-X	
.X	±0.38	.X	±3°	SHEET SIZE	A4		
.XX	±0.25	.XX	±2°	KLS P/N:			
Draw by: Date		2018-03-01		 NingBo KLS ELECTRONIC CO.,L TD.			
Check by: Date		2018-03-01					
SCALE		SHEET		OF			