



AC Power Sockets*AC Plugs

KLS1-AS-305-1 AC Power Sockets*AC Plugs

Material:

Material(External): Nylon PA66 PC
 Rating Voltage: 250V 10A
 Humidity: 93%+40
 Insulation: $\geq 100M\Omega$
 Withstand Voltage: AC 500V(50Hz)/min

Electrical Characteristics:

Conduct Material: COPPER
 Temperature Range: $-40^{\circ}C + 70^{\circ}C$
 Contact Resistance: $\leq 0.03\Omega$
 Actuating Force: 5-40N
 Lifespan: 10000times

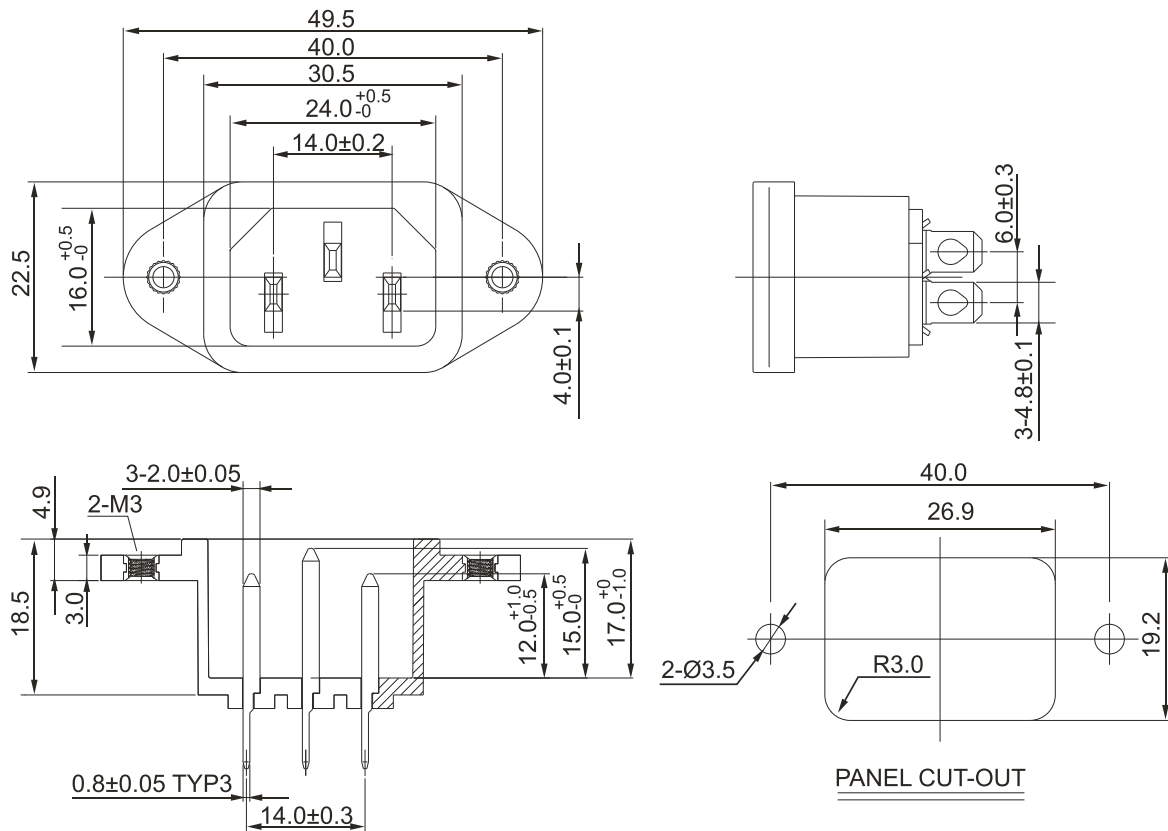

ORDER INFORMATION

Product NO.: KLS1 - AS-305-1

