

Mini Microphone

Unidirectional mini microphone MU9750 Serie

Specifications:

- Sensitivity(1KHz,0dB=1V/Pa):-47±3dB
- Directivity:Unidirectional
- Impedance:2.2KΩ Max.
- Current consumption:0.5mA Max.
- Operation voltage:1.0~10V
- S/N ratio:60dB Min.
- Sensitivity vs. Voltage:3dB Max. at VS=2.0V~1.5V
- Std. Test Condition:94dB S.P.L @1KHz VS=2.0V
- Frequency:20~16,000Hz

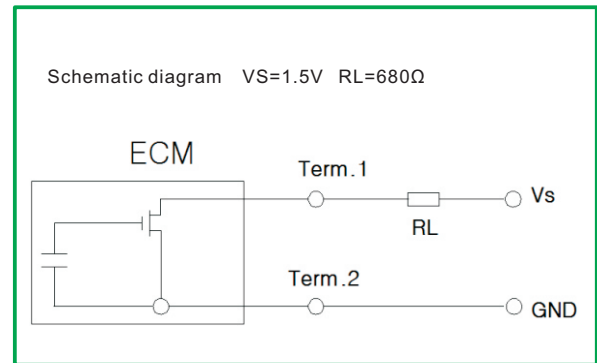
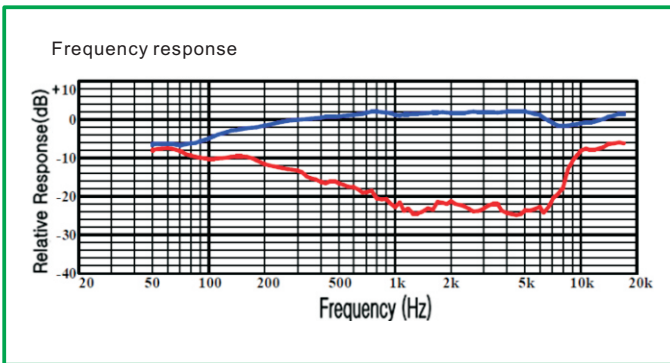
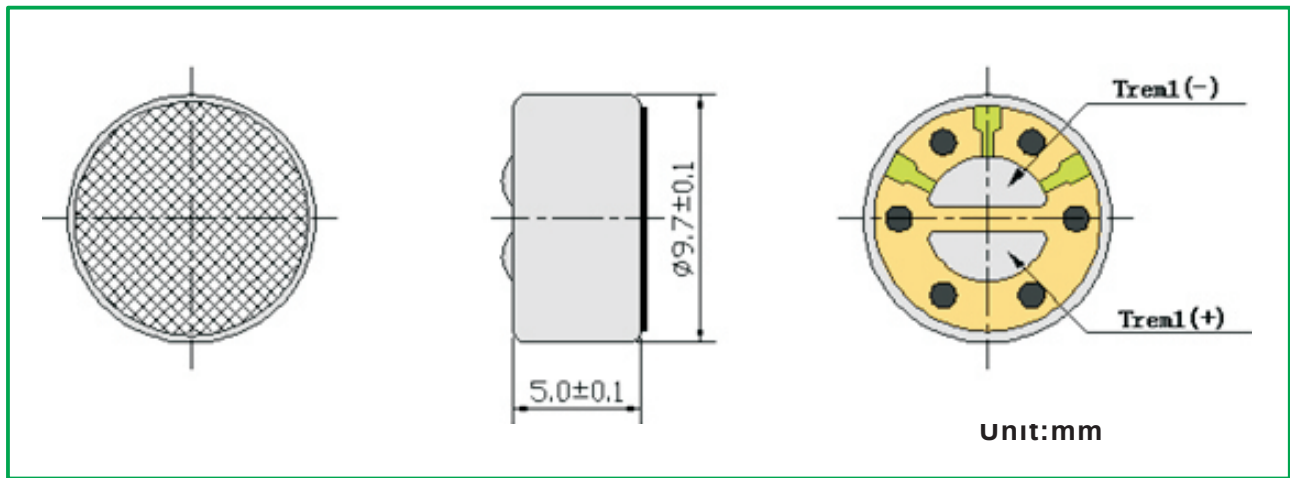

ORDER INFORMATION

Product NO.: **KLS3 - MU 9750 P - 473**

- Unidirectional mini microphone Series
- Dimensions
- Note: Soldering
- P: Pin Type
- W: Wire type
- Sensitivity