

HF62F

MINIATURE HIGH POWER RELAY



File No.:E133481



File No.:R50147086



File No.:CQC09002028470



Features

- 20A switching capability
- 5kV dielectric strength (between coil and contacts)
- 10kV impulse withstand voltage (between coil and contacts)
- creepage distance: 8mm
- PCB & QC layouts available
- UL insulation system: Class F available
- Environmental friendly product (RoHS compliant)
- Outline Dimensions: (29.0 x 12.6 x 24.2) mm

CONTACT DATA

Contact arrangement	1A
Contact resistance	50mΩ max.(at 1A 6VDC)
Contact material	AgSnO ₂
Contact rating (Res. load)	16A 250VAC 16A 30VDC
Max. switching voltage	277VAC / 30VDC
Max. switching current	20A
Max. switching power	4000VAC / 480W
Mechanical endurance	1 x 10 ⁷ OPS
Electrical endurance	1 x 10 ⁵ OPS (16A 250VAC, Resistive load, Room temp., 3s on 3s off)

CHARACTERISTICS

Insulation resistance	1000MΩ (at 500VDC)	
Dielectric strength	Between coil & contacts	5000VAC 1min
	Between open contacts	1000VAC 1min
Operate time (at nomi. volt.)	20ms max.	
Release time (at nomi. volt.)	10ms max.	
Humidity	5% to 85% RH	
Ambient temperature	Class B	-40°C to 70°C
	Class F	-40°C to 85°C
Shock resistance	Functional	98m/s ²
	Destructive	980m/s ²
Vibration resistance	10Hz to 55Hz 1.5mm DA	
Termination	T type: PCB D type, Standard: PCB & QC	
Unit weight	Approx.15g	
Construction	Flux proofed	

- Notes:** 1) The data shown above are initial values.
2) Please find coil temperature curve in the characteristic curves below.
3) UL insulation system: Class F, Class B.

COIL

Coil power Approx. 540mW

COIL DATA

at 23°C

Nominal Voltage VDC	Pick-up Voltage VDC max.	Drop-out Voltage VDC min.	Max. Voltage VDC *	Coil Resistance Ω
5	4.0	0.5	6.50	47 x (1±10%)
6	4.8	0.6	7.80	68 x (1±10%)
9	7.2	0.9	11.7	155 x (1±10%)
12	9.6	1.2	15.6	270 x (1±10%)
18	14.4	1.8	23.4	620 x (1±10%)
24	19.2	2.4	31.2	1100 x (1±10%)
48	38.4	4.8	62.4	4400 x (1±10%)

Notes: *Maximum voltage refers to the maximum voltage which relay coil could endure in a short period of time.

SAFETY APPROVAL RATINGS

UL/CUL	16A 250VAC
	16A 30VDC
	20A 125VAC
TÜV	16A 250VAC COSØ=1
	16A 30VDC COSØ=1

- Notes:** 1) All values unspecified are at room temperature.
2) Only typical loads are listed above. Other load specifications can be available upon request.



HONGFA RELAY

ISO9001, ISO/TS16949, ISO14001, OHSAS18001, IECQ QC 080000 CERTIFIED

2014 Rev. 1.01

ORDERING INFORMATION

Type		HF62F / 012 -1H T F (XXX)			
Coil voltage	5, 6, 9, 12, 18, 24, 48VDC				
Contact arrangement	1H: 1 Form A				
Termination	T: PCB	D: PCB & Bended QC	Nil: PCB & QC		
Insulation Standard	F: Class F	Nil: Class B			
Customer special code					

OUTLINE DIMENSIONS, WIRING DIAGRAM AND PC BOARD LAYOUT

Unit: mm

Outline Dimensions

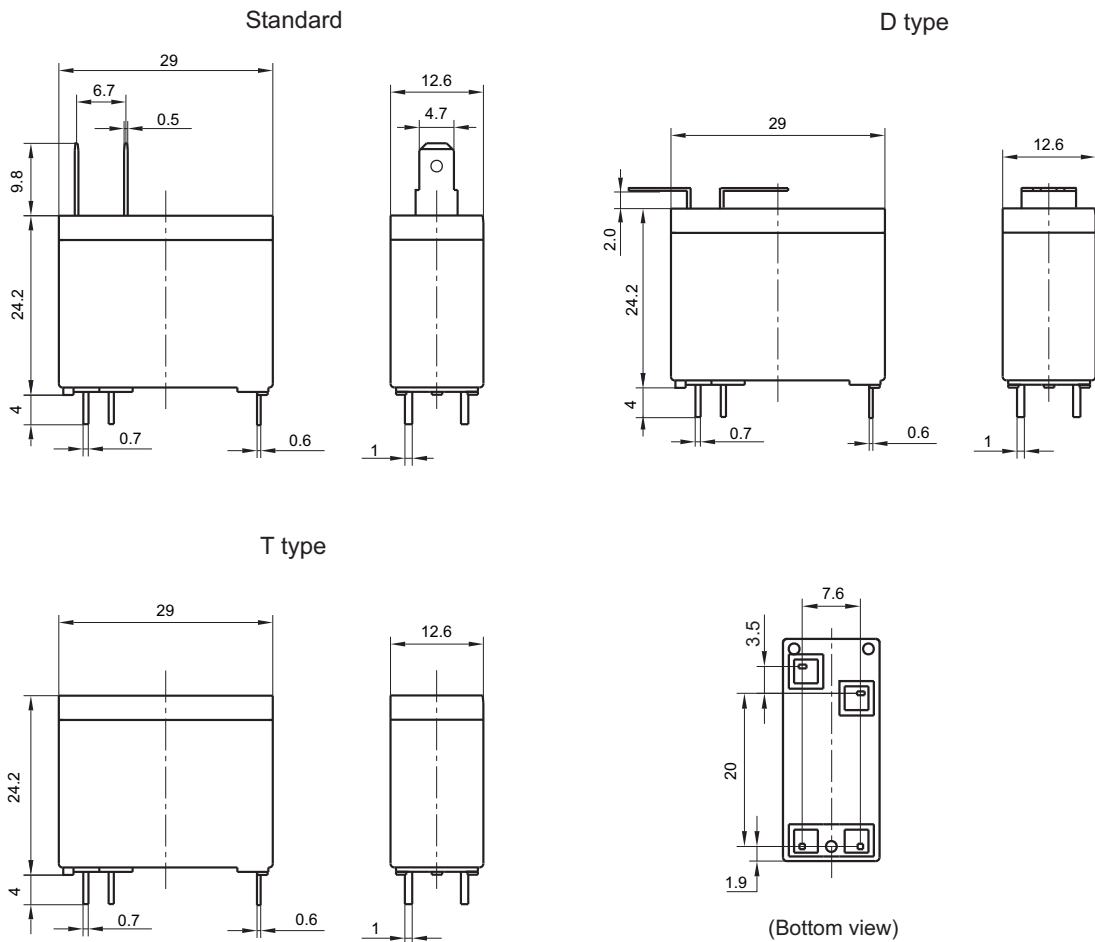

OUTLINE DIMENSIONS, WIRING DIAGRAM AND PC BOARD LAYOUT

Unit: mm

Wiring Diagram

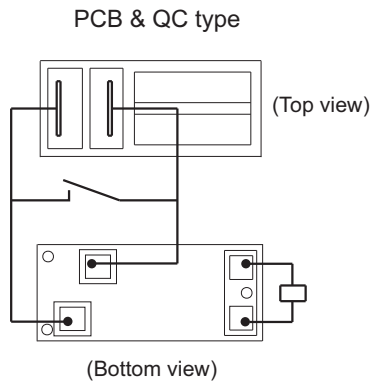

PCB type

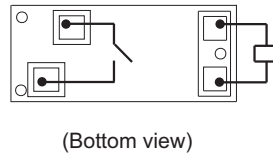

PCB Layout (Bottom view)

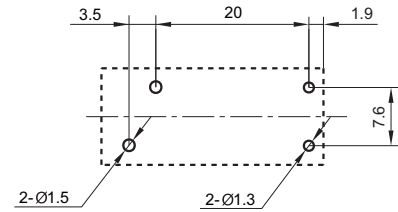

- Remark: 1) In case of no tolerance shown in outline dimension: outline dimension $\leq 1\text{mm}$, tolerance should be $\pm 0.2\text{mm}$; outline dimension $> 1\text{mm}$ and $\leq 5\text{mm}$, tolerance should be $\pm 0.3\text{mm}$; outline dimension $> 5\text{mm}$, tolerance should be $\pm 0.4\text{mm}$.
 2) The tolerance without indicating for PCB layout is always $\pm 0.1\text{mm}$.

CHARACTERISTIC CURVES

MAXIMUM SWITCHING POWER

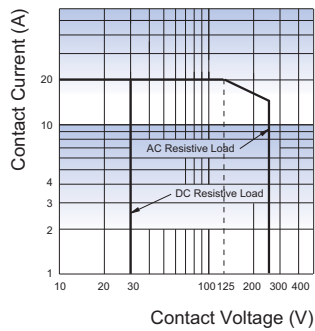

ENDURANCE CURVE

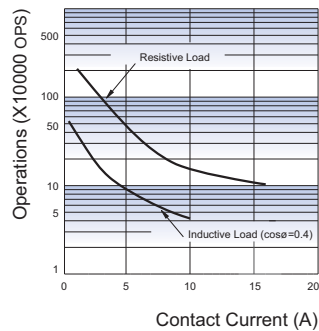

Test conditions:
Room temp., 3s on 3s off

COIL TEMPERATURE RISE

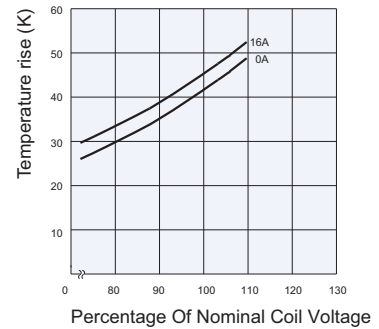

Disclaimer

The specification is for reference only. See to "Terminology and Guidelines" for more information. Specifications subject to change without notice. We could not evaluate all the performance and all the parameters for every possible application. Thus the user should be in a right position to choose the suitable product for their own application. If there is any query, please contact Hongfa for the technical service. However, it is the user's responsibility to determine which product should be used only.