



KLS ELECTRONIC CO.,LTD

KLS23-24HS SERIES 1.8°

Key Features

- Very High Torque
- Smooth Movement
- Low Speed

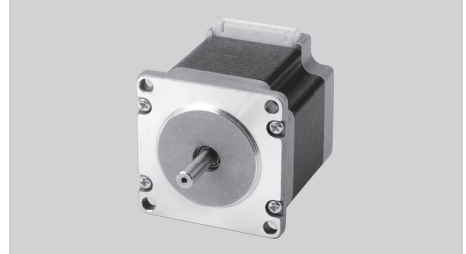

General Specifications

- Bi-polar

Series & Length	Model Number	Holding Torque		Rated Current	Resistance per Phase	Inductance per Phase	Detent Torque		Rotor Inertia	
		mNm	oz-in	A	ohm	mH	mNm	oz-in	g.cm ²	oz-in ²
24HS1 44 mm (1.73 in.)	24HS1001N	1100	155.9	1.4	2.9	6.6	40	5.67	280	1.54
	24HS1002N	1100	155.9	2.8	0.75	1.6				
	24HS1003N	1100	155.9	4	0.35	0.85				
24HS2 54 mm (2.13 in.)	24HS2002N	1400	198.4	4	0.42	1.2	90	12.75	450	2.47
	24HS2001N	1800	255.1	2.8	1.1	3.5				
24HS3 65 mm (2.56 in.)	24HS3003N	2100	297.6	1.4	4.3	13.5	95	13.46	560	3.08
	24HS3004N	2100	297.6	2.8	1.1	3.3				
24HS5 85 mm (3.35 in.)	24HS5001N	3000	425.2	2.8	1.49	6.5	100	14.16	900	4.95
	24HS5002N	3000	425.2	4	0.65	2.45				
	24HS5003N	3000	425.2	1.4	5.96	25				

- Uni-polar

Series & Length	Model Number	Holding Torque		Rated Current	Resistance per Phase	Inductance per Phase	Detent Torque		Rotor Inertia	
		mNm	oz-in	A	ohm	mH	mNm	oz-in	g.cm ²	oz-in ²
24HS1 44 mm (1.73 in.)	24HS1002-01N	950	134.6	2	1.46	1.8	40	5.67	280	1.54
	24HS1003-01N	950	134.6	2.8	0.74	0.85				
	24HS1004N	950	134.6	1	5.7	6.8				
24HS2 54 mm (2.13 in.)	24HS2003N	1200	170.1	3	0.85	1.34	90	12.75	450	2.47
	24HS2004N	1200	170.1	2	1.9	3.27				
	24HS2005N	1200	170.1	1	6.9	11.5				
24HS3 65 mm (2.56 in.)	24HS3005N	1500	212.6	2	2.2	3.5	95	13.46	560	3.08
24HS5 85 mm (3.35 in.)	24HS5001-01N	2300	326.0	2	2.8	6.4	100	14.16	900	4.95
	24HS5002-01N	2300	326.0	3	1.2	2.54				
	24HS5004N	2300	326.0	1	10	19.5				

- Wiring Connection, Lead Wires, Schematic Diagrams & Stepping Sequence.....Page 62 - 64



Mechanical Dimension

Series	L	Mass
	mm (in.)	kg (lb.)
24HS1	44 (1.73)	0.60 (1.32)
24HS2	54 (2.13)	0.83 (1.83)
24HS3	65 (2.56)	1.05 (2.31)
24HS5	85 (3.35)	1.40 (3.09)

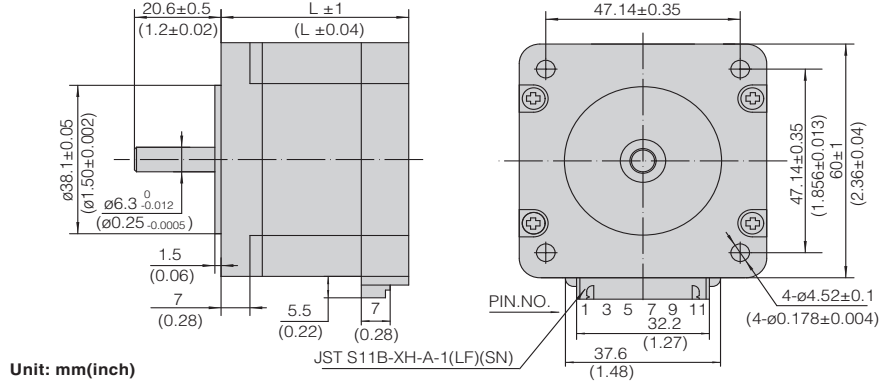

Dynamic Torque Curves

- Bi-polar

24HS1001N

Conditions: Bi-polar Constant Current Driver
Driver: AMA MS3540M
Mode: Full Step

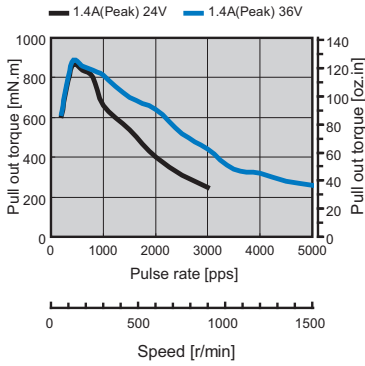

24HS1002N

Conditions: Bi-polar Constant Current Driver
Driver: AMA MS3540M
Mode: Full Step

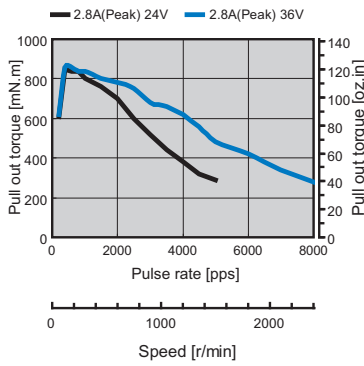

24HS1003N

Conditions: Bi-polar Constant Current Driver
Driver: AMA MS3540M
Mode: Full Step

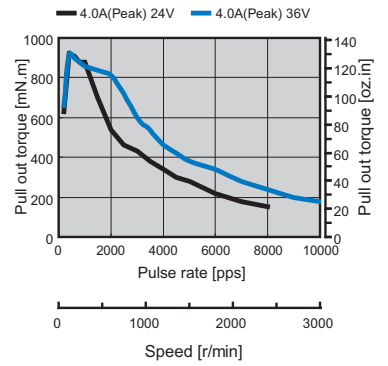

24HS2001N

Conditions: Bi-polar Constant Current Driver
Driver: AMA MS3540M
Mode: Full Step

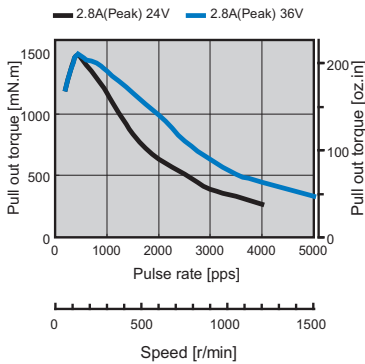

24HS2002N

Conditions: Bi-polar Constant Current Driver
Driver: AMA MS3540M
Mode: Full Step

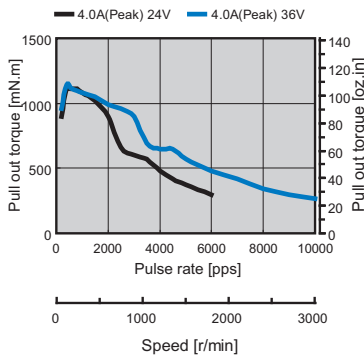

24HS3003N

Conditions: Bi-polar Constant Current Driver
Driver: AMA MS3540M
Mode: Full Step

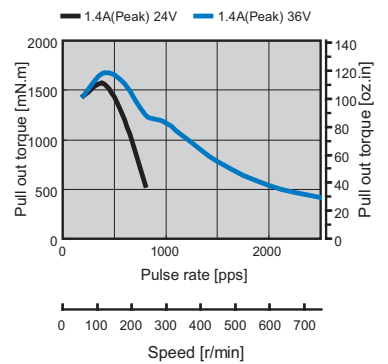



Dynamic Torque Curves

• Bi-polar

24HS3004N

Conditions: Bi-polar Constant Current Driver
Driver: AMA MS3540M
Mode: Full Step

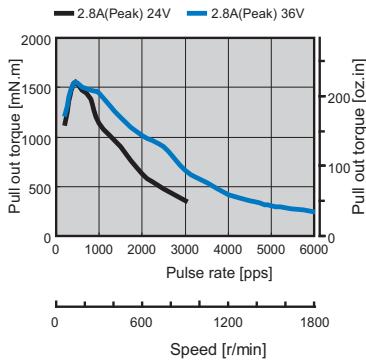

24HS5001N

Conditions: Bi-polar Constant Current Driver
Driver: AMA MS3540M
Mode: Full Step

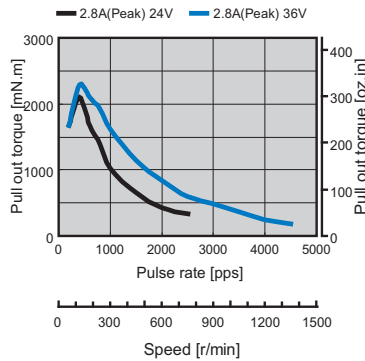

24HS5002N

Conditions: Bi-polar Constant Current Driver
Driver: AMA MS3540M
Mode: Full Step

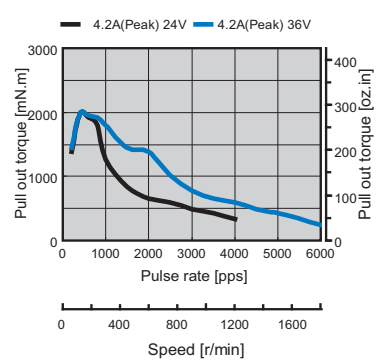

24HS5003N

Conditions: Bi-polar Constant Current Driver
Driver: AMA MS3540M
Mode: Full Step

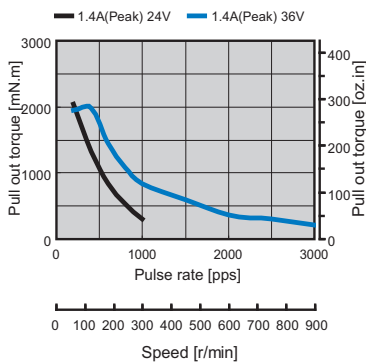

• Uni-polar

24HS1002-01N

Conditions: Uni-polar Constant Current Driver
Driver: AMA MSU3040M
Mode: Full Step

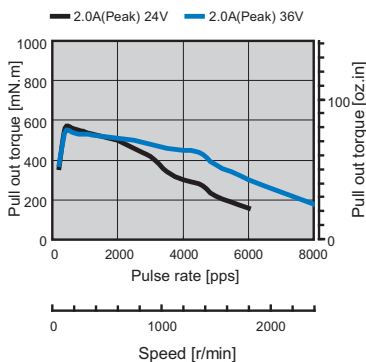

24HS1003-01N

Conditions: Uni-polar Constant Current Driver
Driver: AMA MSU3040M
Mode: Full Step

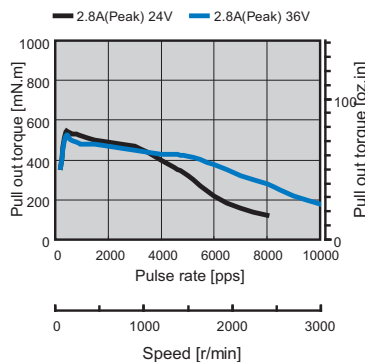

24HS1004N

Conditions: Uni-polar Constant Current Driver
Driver: AMA MSU3040M
Mode: Full Step

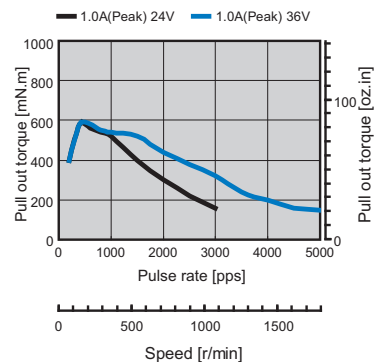

Dynamic Torque Curves

- Uni-polar

24HS2003N

Conditions: Uni-polar Constant Current Driver
Driver: AMA MSU3040M
Mode: Full Step

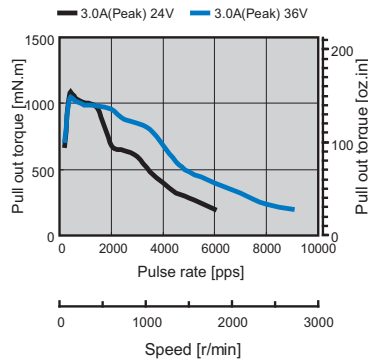

24HS2004N

Conditions: Uni-polar Constant Current Driver
Driver: AMA MSU3040M
Mode: Full Step

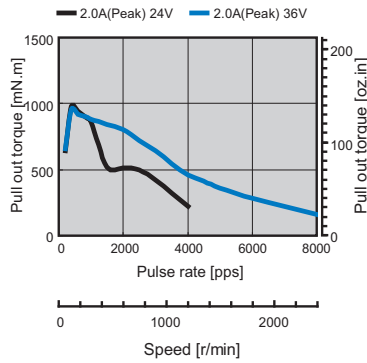

24HS2005N

Conditions: Uni-polar Constant Current Driver
Driver: AMA MSU3040M
Mode: Full Step

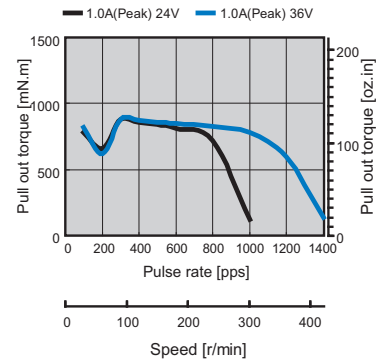

24HS3005N

Conditions: Uni-polar Constant Current Driver
Driver: AMA MSU3040M
Mode: Full Step

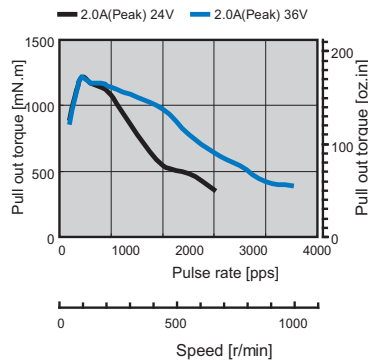

24HS5001-01N

Conditions: Uni-polar Constant Current Driver
Driver: AMA MSU3040M
Mode: Full Step

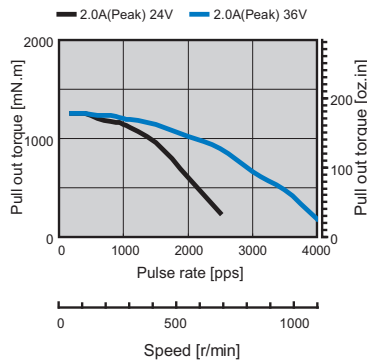

24HS5002-01N

Conditions: Uni-polar Constant Current Driver
Driver: AMA MSU3040M
Mode: Full Step

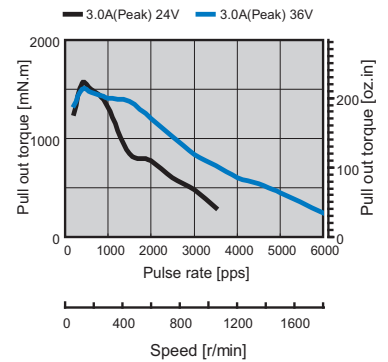

24HS5004N

Conditions: Uni-polar Constant Current Driver
Driver: AMA MSU3040M
Mode: Full Step

