

**LED Series**

**KLS9-L Ultra Bright LED Lamp Series**



KLS9 - L - CM 501 2 BH C - XXX  
 1                      2                      3                      4                      5                      6                      7

- 1. Brank: KLS ELECTRONIC
- 2. Digit Mode: L-Lamp
- 3. Package Type (style):
- 4. Leads Type:

- 0: Surface Mounting Lead for SMD
- 1: 20mm Lead Length with Stand-off
- 2: 18mm Lead Length Standard
- 3: 25.4mm Lead Length with big Reflector
- 4: 25.4mm Lead Length with small Reflector
- 5: 25.4mm Lead Length with 3 Leads for bi-color
- 7: 25.4mm Lead Length with 2 Leads for bi-color
- 9: 25.4mm Lead Length with 3 Leads for bi-color

5. Color Code:

H: Red	GaP / GaP	700nm	UG: High Bright Green	AlGaInP 574nm
S: High Bright Red	GaAlAs / GaAs	SH 660nm	PG: Super Pure Green	AlGaInP 525nm
D: Super Bright Red	GaAlAs / GaAs	DH 660nm	BG: Super Bluish Green	AlGaInP 505nm
UR: Ultra Bright Red	GaAlAs / GaAlAs	DDH 660nm	B: Blue GaN / SiC	430nm
UHR: Ultra Bright Red	AlGaInP	640nm	UB: Super Bright Blue	InGaN / SiC 470nm
E: Orange	GaAsP / GaP	635nm	V: UV	InGaN / SiC405nm
UE: High Bright Orange	AlGaInP	630nm	W: White	
Y: Yellow	GaAsP / GaP	585nm	EG: Orange + Green Bi-Color	
UY: High Bright Yellow	AlGaInP	590nm	SG: High Red + Green Bi-Col	
G: Green	GaP / GaP	568nm	BH:Red/Blue	

- 6. Len Color: D: Color Diffused      T: Color Transparent      C: Water Clear      W: White Diffused  
 CD: Color Top Diffused      WD: White Top Diffused      E: Orange Diffused

7. Special Operation & Other:

**NOTES**

- 1.All dimensions are in millimeters .
- 2.Tolerance is ±0.25mm unless otherwise noted.
- 3.Protruded resin under flange is 1.0mm max.
- 4.Lead spacing is measured where the leads emerge from the package.
- 5.Specifications are subject to change without notice.

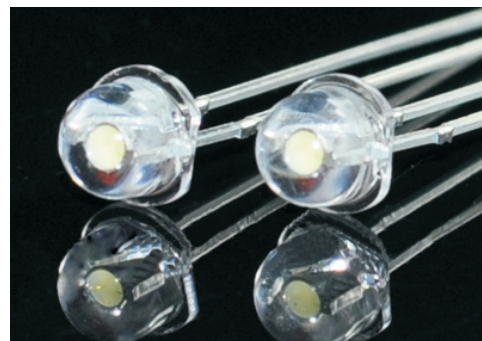

Lens	Material	Emitting Color
White Diffused	Al.Ga.In.P/In.Ga.N	Red/Blue

## LED Series

### KLS9-L Ultra Bright LED Lamp Series

#### Package Dimensions

IX

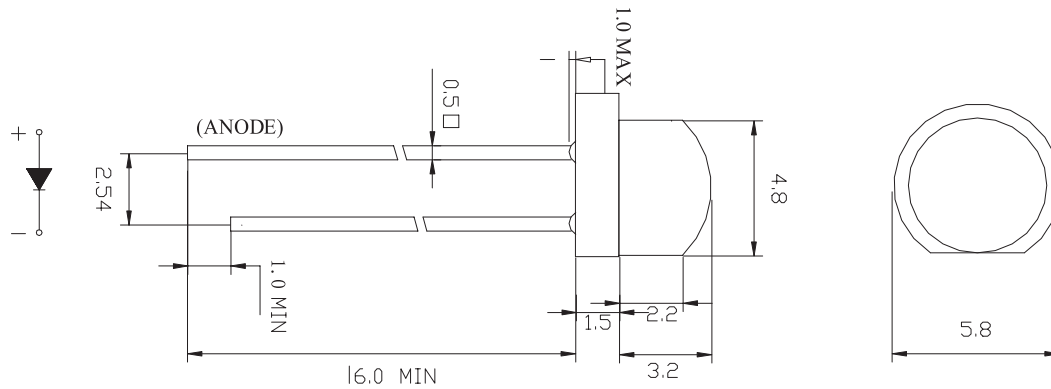

#### Absolute Maximum Rating

Parameter	Maximum Rating	Unit
Power Dissipation	100	mW
Peak Forward Current(1/10 Duty Cycle,0.1ms Pulse Width)	50	mA
DC Forward Current	40	mA
Reverse Voltage	5	V
Electrostatic Discharge	1000	V
Operating Temperature Range	-25°C~+80°C	
Storage Temperature Range	-40°C~+80°C	
Lead Soldering Temperature [1.6mm(.063") From Body]	330°C for35 sec Max.	

#### Typical Electrical / Optical Characteristics

Parameter	Symbol	Min.	Typ.	Max.	Unit	Test Condition
Viewing Angle	2θ 1/2	/	/	100	deg	IF=40mA
Forward Voltage	VF	4.0	/	4.5	V	IF=40mA
Reverse Current	IR	/	10	/	u A	VR=5V
Light Intensity	IV	R	1500	/	2500	IF=20mA
		B	5000	/	7000	
Wavelength	WLD	R:620	/	630	nm	IF=40mA
		B:455	/	470		
Flicker Frequency	IV	/	1.5	/	/Hz	IF=40mA
Recommend Forward Current	IF(rec)	/	/	40	mA	IF=40mA

**LED Series**

**KLS9-L Ultra Bright LED Lamp Series**



Typical electrical-optical  
Characteristics curves

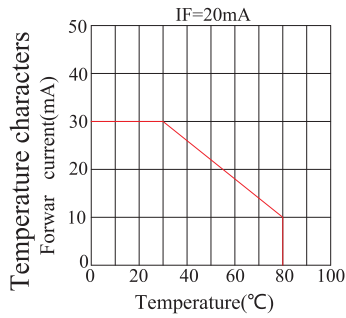
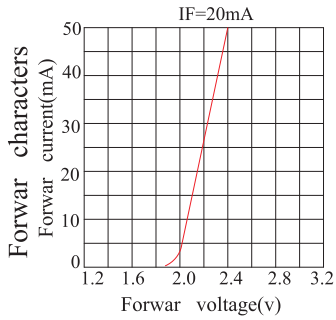

**Notes:**

The data are an typical presentation of the product, Contact customer service for details of technical information and warranty.  
The product is sensitive to static antistatic operation environment is recommended  
Products are shipped in either bulk bag package or taping.

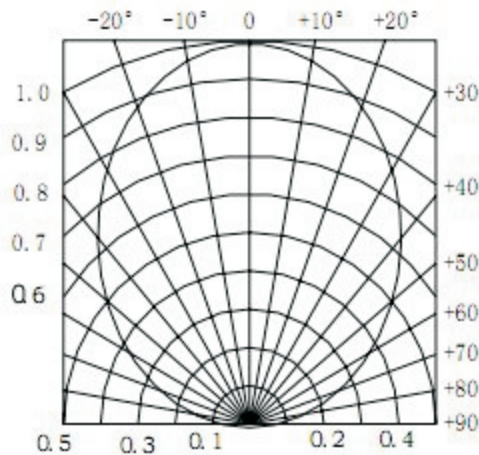
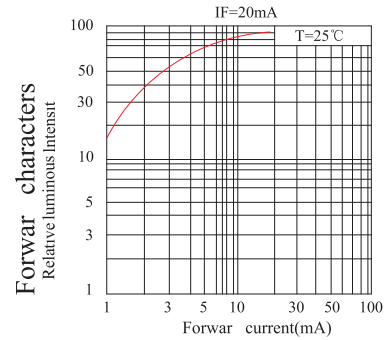
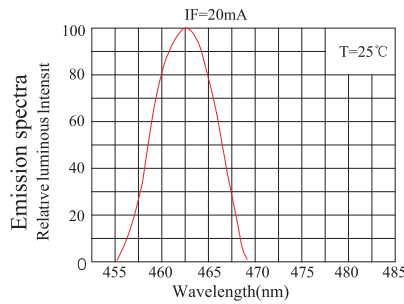
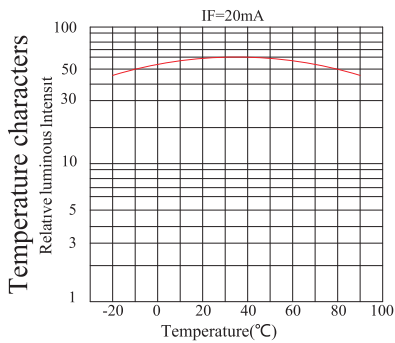

Emitted Angle 100°

## LED Series

### KLS9-L Ultra Bright LED Lamp Series

## LED LAMP RELIABILITY

### ● Test Items And Results

Type	Test Item	REF. Standard	Test Condition	Note	Number of Damage
Environmental Sequence	Temperature Cycle	JIS C 7021 (1997) A-4	-20°C → 25°C → 80°C → 25°C 30mins,5mins,30mins,5mins	100 cycles	0/100
	High Humidity Heat Cycle	JIS C 7021 (1997) A-5	30°C → 65°C 90%RH 24hrs/1cycle	10 cycles	0/100
	High Temperature Storage	JIS C 7021 (1997) B-10	Ta=80°C	1000hrs	0/100
	Humidity Heat Storage	JIS C 7021 (1997) B-11	Ta=60°C RH=90%	1000hrs	0/100
	Low Temperature Storage	JIS C 7021 (1997) B-12	Ta= -30°C	1000hrs	0/100
Operation Sequence	Life Test	JIS C 7035 (1985)	Ta=25°C If=20mA	1000hrs	0/100
	High Humidity Heat Life Test	*	60°C RH=90% If=20mA	500hrs	0/100
	Low Temperature Life Test	*	Ta= -20°C If=20mA	1000hrs	0/100
Destructive Sequence	Resistance to Soldering Heat	JIS C 7021 (1997) A-11	Tsol=260 ± 5°C,10sec (3mm from the base of the epoxy bulb)	1 time	0/20
	Solderability	JIS C 7021 (1997) A-2	Tsol=235 ± 5°C,5sec (Using flux)	1 time (over 95%)	0/20
	Lead Pull/Bend Test	JIS C 7021 (1997)A-11	Loa 2.5N (0.25kgf) 0° → 90° → 0° Bend 3 times	No noticeable damage	0/20

\* Refer to reliability test standard specification for in this line.

### ● Criteria for Judging The Damage

Item	Symbol	Test Condition	Criteria for Judgment	
			Min.	Max.
Forward Voltage	V <sub>F</sub>	I <sub>F</sub> = 20mA	---	Initial data x 1.1
Reverse Current	I <sub>R</sub>	V <sub>R</sub> = 5V	---	Initial data x 2.0
Luminous Intensity	I <sub>v</sub>	I <sub>F</sub> = 20mA	Initial data x 0.7	---